

Code	Smart Code	Outlet	Size		Price \$	LINE
------	------------	--------	------	---	----------	------

LOW LEVEL

4012.0Y050A.020.1	21668	Ø 50	20 cm	12	10.99
4012.0Y050A.033.1	21634	Ø 50	33 cm	12	13.33
4012.0Y050A.040.1	21645	Ø 50	40 cm	12	14.67
4012.0Y050A.050.1	21658	Ø 50	50 cm	12	16.50
4012.0Y050A.060.1	21684	Ø 50	60 cm	12	18.67

LOW LEVEL

4012.0A050A.020.1	21536	Ø 50	20 cm	12	10.99
4012.0A050A.033.1	21552	Ø 50	33 cm	12	13.33
4012.0A050A.040.1	21565	Ø 50	40 cm	12	14.67
4012.0A050A.050.1	21575	Ø 50	50 cm	12	16.50
4012.0A050A.060.1	21585	Ø 50	60 cm	12	18.67

* Shower drain / Ø 50 side-vertical outlet / Plastic body / Stainless grid / Odor blocking by water
 * Душевой канал / Ø 50 боковой-Нижний выход / пластичное тело / Нержавеющая решетка / Гидрозатвор
 قناة دش / هيكل بلاستيكي / مع مخرج ٥٠ ملم / و شبكة مقاومه للصدأ / مع مانع الروائح الكريهة



Code	Smart Code	Outlet	Size		Price \$	LINE
------	------------	--------	------	---	----------	------

4012.0Y050K.020.1	14414	Ø 50	20 cm	12	10.99
4012.0Y050K.033.1	14431	Ø 50	33 cm	12	13.33
4012.0Y050K.040.1	14445	Ø 50	40 cm	12	14.67
4012.0Y050K.050.1	14465	Ø 50	50 cm	12	16.50
4012.0Y050K.060.1	14474	Ø 50	60 cm	12	18.67
4012.0Y050K.080.1	14491	Ø 50	80 cm	12	22.33

4012.0A050K.020.1	14415	Ø 50	20 cm	12	10.99
4012.0A050K.033.1	14430	Ø 50	33 cm	12	13.33
4012.0A050K.040.1	14448	Ø 50	40 cm	12	14.67
4012.0A050K.050.1	14463	Ø 50	50 cm	12	16.50
4012.0A050K.060.1	14488	Ø 50	60 cm	12	18.67
4012.0A050K.080.1	14503	Ø 50	80 cm	12	22.33

* Shower drain / Ø 50 side-vertical outlet / Plastic body / Stainless grid / Odor blocking by water
 * Душевой канал / Ø 50 боковой-Нижний выход / пластичное тело / Нержавеющая решетка / Гидрозатвор
 قناة دش / هيكل بلاستيكي / مع مخرج ٥٠ ملم / و شبكة مقاومه للصدأ / مع مانع الروائح الكريهة



Code	Smart Code	Outlet	Size		Price \$	LINE GOLD
------	------------	--------	------	---	----------	-----------

4012.0Y050G.020.1	14509	Ø 50	20 cm	12	14.67
4012.0Y050G.033.1	14523	Ø 50	33 cm	12	18.83
4012.0Y050G.040.1	14533	Ø 50	40 cm	12	20.67
4012.0Y050G.050.1	14550	Ø 50	50 cm	12	25.00
4012.0Y050G.060.1	14566	Ø 50	60 cm	12	28.33
4012.0Y050G.080.1	14585	Ø 50	80 cm	12	33.33

4012.0A050G.020.1	14526	Ø 50	20 cm	12	14.67
4012.0A050G.033.1	14545	Ø 50	33 cm	12	18.83
4012.0A050G.040.1	14570	Ø 50	40 cm	12	20.67
4012.0A050G.050.1	14586	Ø 50	50 cm	12	25.00
4012.0A050G.060.1	14600	Ø 50	60 cm	12	28.33
4012.0A050G.080.1	14623	Ø 50	80 cm	12	33.33

* Shower drain / Ø 50 side-vertical outlet / Plastic body / Stainless grid / Odor blocking by water
 * Душевой канал / Ø 50 боковой-Нижний выход / пластичное тело / Нержавеющая решетка / Гидрозатвор
 قناة دش / هيكل بلاستيكي / مع مخرج ٥٠ ملم / و شبكة مقاومه للصدأ / مع مانع الروائح الكريهة



LEGAL

Code	Smart Code	Outlet	Size	Icon	Price \$
4013.0Y050K.020.1	14602	Ø 50	20 cm	12	23.32
4013.0Y050K.033.1	14613	Ø 50	33 cm	12	28.33
4013.0Y050K.040.1	14626	Ø 50	40 cm	12	31.67
4013.0Y050K.050.1	14636	Ø 50	50 cm	12	37.00
4013.0Y050K.060.1	14649	Ø 50	60 cm	12	42.00
4013.0Y050K.080.1	14668	Ø 50	80 cm	12	51.67

4013.0A050K.020.1	14651	Ø 50	20 cm	12	23.32
4013.0A050K.033.1	14667	Ø 50	33 cm	12	28.33
4013.0A050K.040.1	14685	Ø 50	40 cm	12	31.67
4013.0A050K.050.1	14701	Ø 50	50 cm	12	37.00
4013.0A050K.060.1	14722	Ø 50	60 cm	12	42.00
4013.0A050K.080.1	14734	Ø 50	80 cm	12	51.67

* Shower drain / Ø 50 side-vertical outlet / Plastic body / Stainless grid / Odor blocking by water

* Душевой канал / Ø 50 боковой-Нижний выход / Корпус Из Нержавеющей / Нержавеющая решетка / Гидрозатвор

قناة دش / هيكل مقاوم للصدأ / مع مخرج ٥٠ ملم / و شبكة مقاومه للصدأ / مع مانع الروائح الكريهة



LEGAL GOLD

Code	Smart Code	Outlet	Size	Icon	Price \$
4013.0Y050G.020.1	14683	Ø 50	20 cm	12	24.83
4013.0Y050G.033.1	14702	Ø 50	33 cm	12	34.00
4013.0Y050G.040.1	14710	Ø 50	40 cm	12	38.50
4013.0Y050G.050.1	14731	Ø 50	50 cm	12	44.82
4013.0Y050G.060.1	14749	Ø 50	60 cm	12	51.67
4013.0Y050G.080.1	18284	Ø 50	80 cm	12	63.17

4013.0A050G.020.1	14755	Ø 50	20 cm	12	24.83
4013.0A050G.033.1	14778	Ø 50	33 cm	12	34.00
4013.0A050G.040.1	14793	Ø 50	40 cm	12	38.50
4013.0A050G.050.1	14813	Ø 50	50 cm	12	44.82
4013.0A050G.060.1	14827	Ø 50	60 cm	12	51.67
4013.0A050G.080.1	18351	Ø 50	80 cm	12	63.17

* Shower drain / Ø 50 side-vertical outlet / Plastic body / Stainless grid / Odor blocking by water

* Душевой канал / Ø 50 боковой-Нижний выход / Корпус Из Нержавеющей / Нержавеющая решетка / Гидрозатвор

قناة دش / هيكل مقاوم للصدأ / مع مخرج ٥٠ ملم / و شبكة مقاومه للصدأ / مع مانع الروائح الكريهة

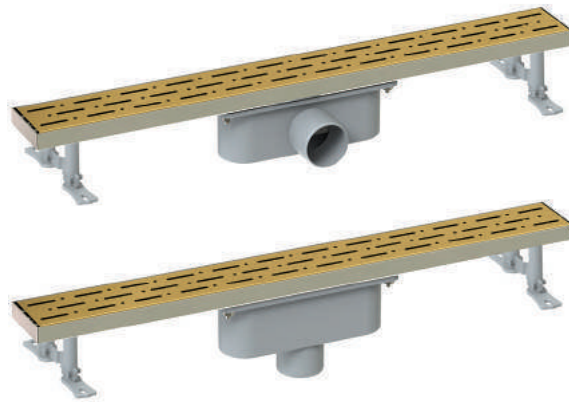

CLASSIC SERIES

Code Smart Code Outlet Size Price \$ LEGAL 360°

4013.00360K.020.1	14781	Ø 50	20 cm	12	24.00
4013.00360K.033.1	14797	Ø 50	33 cm	12	28.83
4013.00360K.040.1	14810	Ø 50	40 cm	12	32.00
4013.00360K.050.1	14829	Ø 50	50 cm	12	35.50
4013.00360K.060.1	14845	Ø 50	60 cm	12	39.99
4013.00360K.080.1	14859	Ø 50	80 cm	12	47.00



* Shower drain / Ø 50 side outlet / Stainless body / Stainless steel grid and frame / Odor blocking by water
 * Душевой канал / Ø 50 боковой выход / Корпус Из Нержавеющей / Нержавеющая решетка / Гидрозатвор
 قناة دش/ هيكل مقاوم للصدأ / مع مخرج متحرك ٣٦٠ درجة ٥٠ ملم / و شبكة مقاومه للصدأ / مع مانع الروائح الكريهة

Code Smart Code Outlet Size Price \$ LEGAL GOLD 360°

4013.00360G.020.1	14868	Ø 50	20 cm	12	30.00
4013.00360G.033.1	14878	Ø 50	33 cm	12	35.83
4013.00360G.040.1	14892	Ø 50	40 cm	12	39.83
4013.00360G.050.1	14903	Ø 50	50 cm	12	45.83
4013.00360G.060.1	14926	Ø 50	60 cm	12	50.68
4013.00360G.080.1	14961	Ø 50	80 cm	12	63.00



* Shower drain / Ø 50 side outlet / Stainless body / Stainless steel grid and frame / Odor blocking by water
 * Душевой канал / Ø 50 боковой выход / Корпус Из Нержавеющей / Нержавеющая решетка / Гидрозатвор
 قناة دش/ هيكل مقاوم للصدأ / مع مخرج متحرك ٣٦٠ درجة ٥٠ ملم / و شبكة مقاومه للصدأ / مع مانع الروائح الكريهة

SHOWER DRAINS

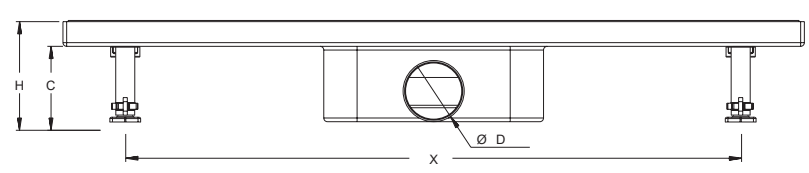
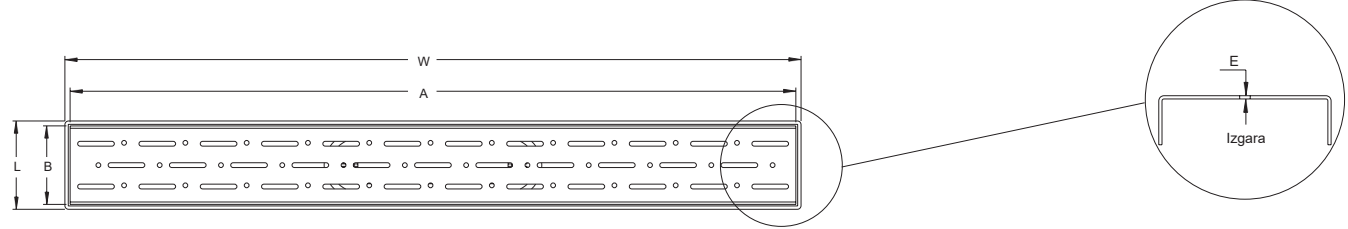

	W	L	H	Ø D	A	B	C	X	E
4012.0Y050K.020.1	205	72	88	49.5	196	64	68	-	1
4012.0Y050K.033.1	330	72	88	49.5	322	64	68	285	1
4012.0Y050K.040.1	400	72	88	49.5	392	64	68	335	1
4012.0Y050K.050.1	500	72	88	49.5	492	64	68	435	1
4012.0Y050K.060.1	600	72	88	49.5	592	64	68	556	1
4012.0Y050K.080.1	785	72	88	49.5	778	64	68	737	1

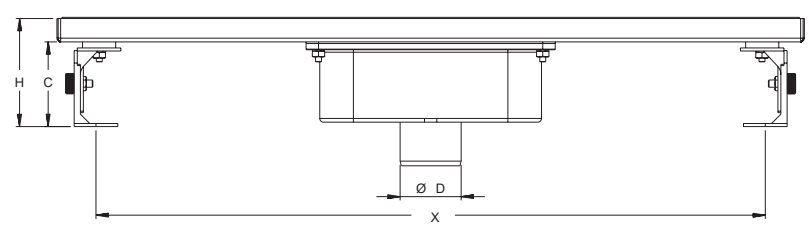

	W	L	H	Ø D	A	B	C	X	E
4012.0A050K.020.1	205	72	115	49.5	196	64	68	-	1
4012.0A050K.033.1	330	72	115	49.5	322	64	68	285	1
4012.0A050K.040.1	400	72	115	49.5	392	64	68	335	1
4012.0A050K.050.1	500	72	115	49.5	492	64	68	435	1
4012.0A050K.060.1	600	72	115	49.5	592	64	68	556	1
4012.0A050K.080.1	785	72	115	49.5	778	64	68	737	1

Table measure "mm"

LEGAL Y360°

Code	Smart Code	Outlet	Size	Price \$
4013.0Y360K.020.1	14879	Ø 50	20 cm	28.00
4013.0Y360K.033.1	14902	Ø 50	33 cm	32.33
4013.0Y360K.040.1	14916	Ø 50	40 cm	36.67
4013.0Y360K.050.1	14928	Ø 50	50 cm	38.32
4013.0Y360K.060.1	14937	Ø 50	60 cm	41.67
4013.0Y360K.080.1	14946	Ø 50	80 cm	50.00

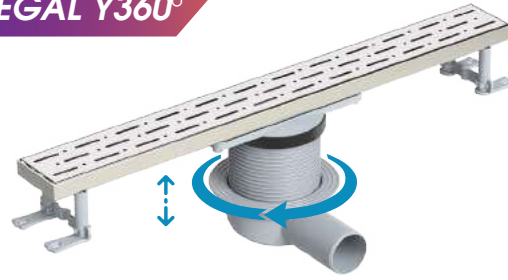

* Shower drain / Ø 50 side outlet / Stainless body / Stainless steel grid and frame / Odor blocking by water
 * Душевой канал / Ø 50 боковой выход / Корпус Из Нержавеющей / Нержавеющая решетка / Гидрозатвор
 قنّاة دش / هيكل مقاوم للصدأ / مع مخرج متحرك 360 درجة 50 ملم / و شبكة مقاومه للصدأ / مع مانع الروائح الكريهة

LEGAL GOLD Y360°

Code	Smart Code	Outlet	Size	Price \$
4013.0Y360G.020.1	14964	Ø 50	20 cm	30.00
4013.0Y360G.033.1	14980	Ø 50	33 cm	36.67
4013.0Y360G.040.1	14993	Ø 50	40 cm	38.00
4013.0Y360G.050.1	15012	Ø 50	50 cm	42.00
4013.0Y360G.060.1	15030	Ø 50	60 cm	46.33
4013.0Y360G.080.1	15057	Ø 50	80 cm	55.33

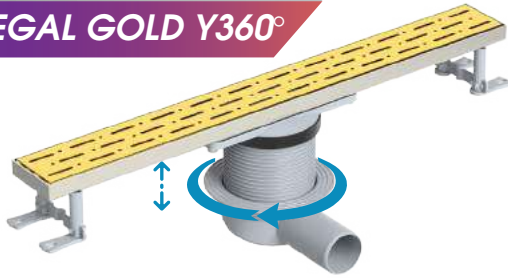

* Shower drain / Ø 50 side outlet / Stainless body / Stainless steel grid and frame / Odor blocking by water
 * Душевой канал / Ø 50 боковой выход / Корпус Из Нержавеющей / Нержавеющая решетка / Гидрозатвор
 قنّاة دش / هيكل مقاوم للصدأ / مع مخرج متحرك 360 درجة 50 ملم / و شبكة مقاومه للصدأ / مع مانع الروائح الكريهة

LEGAL

Code	Smart Code	Outlet	Size	Price \$
4013.0A360K.020.1	14971	Ø 50	20 cm	28.00
4013.0A360K.033.1	14994	Ø 50	33 cm	32.33
4013.0A360K.040.1	15007	Ø 50	40 cm	36.67
4013.0A360K.050.1	15027	Ø 50	50 cm	38.32
4013.0A360K.060.1	15038	Ø 50	60 cm	41.67
4013.0A360K.080.1	15050	Ø 50	80 cm	50.00

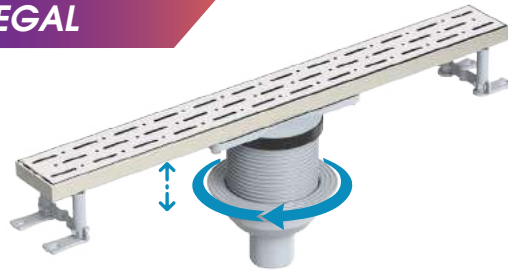

* Shower drain / Ø 50 vertical outlet / Stainless body / Stainless steel grid and frame / Odor blocking by water
 * Душевой канал / Ø 50 боковой выход / Корпус Из Нержавеющей / Нержавеющая решетка / С регулировкой высоты / Гидрозатвор
 قنّاة دش / هيكل مقاوم للصدأ / مع مخرج متحرك 360 درجة 50 ملم / و شبكة مقاومه للصدأ / مع مانع الروائح الكريهة

LEGAL GOLD

Code	Smart Code	Outlet	Size	Price \$
4013.0A360G.020.1	15064	Ø 50	20 cm	30.00
4013.0A360G.033.1	15081	Ø 50	33 cm	36.67
4013.0A360G.040.1	15097	Ø 50	40 cm	38.00
4013.0A360G.050.1	15113	Ø 50	50 cm	42.00
4013.0A360G.060.1	15126	Ø 50	60 cm	46.33
4013.0A360G.080.1	15135	Ø 50	80 cm	55.33

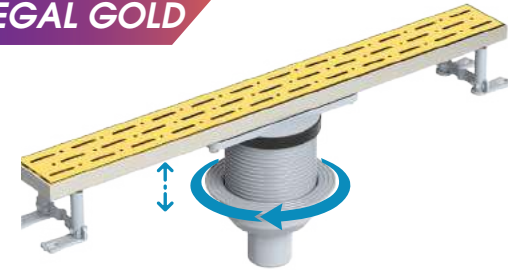

* Shower drain / Ø 50 vertical outlet / Stainless body / Stainless steel grid and frame / Odor blocking by water
 * Душевой канал / Ø 50 боковой выход / Корпус Из Нержавеющей / Нержавеющая решетка / С регулировкой высоты / Гидрозатвор
 قنّاة دش / هيكل مقاوم للصدأ / مع مخرج متحرك 360 درجة 50 ملم / و شبكة مقاومه للصدأ / مع مانع الروائح الكريهة



Code Smart Code Outlet Size Price \$ SCALA

4014.0Y050K.020.1	15086	Ø 50	20 cm	12	24.67
4014.0Y050K.033.1	15087	Ø 50	33 cm	12	30.00
4014.0Y050K.040.1	15088	Ø 50	40 cm	12	32.33
4014.0Y050K.050.1	15090	Ø 50	50 cm	12	36.67
4014.0Y050K.060.1	15092	Ø 50	60 cm	12	42.33
4014.0Y050K.080.1	15095	Ø 50	80 cm	12	50.00
4014.0A050K.020.1	15072	Ø 50	20 cm	12	24.67
4014.0A050K.033.1	15076	Ø 50	33 cm	12	30.00
4014.0A050K.040.1	15078	Ø 50	40 cm	12	32.33
4014.0A050K.050.1	15080	Ø 50	50 cm	12	36.67
4014.0A050K.060.1	15082	Ø 50	60 cm	12	42.33
4014.0A050K.080.1	15084	Ø 50	80 cm	12	50.00



* Shower drain / Ø 50 side-vertical outlet / Stainless steel Compatible with ceramic frame / Odor blocking by water
 * Душевой канал / Ø 50 боковой-Нижний выход / Корпус Из Нержавеющей Керамика совместимая / Запах сочных держател
 قنائة دش/ هيكل مقاوم للصدأ / مع مخرج ٥٠ ملم / و غطاء مقاوم للصدأ من اجل السيراميك / مع مانع الروائح الكريهة

Code Smart Code Outlet Size Price \$ SCALA 360°

4014.00360K.020.1	15099	Ø 50	20 cm	12	26.67
4014.00360K.033.1	15100	Ø 50	33 cm	12	32.33
4014.00360K.040.1	15101	Ø 50	40 cm	12	35.67
4014.00360K.050.1	15103	Ø 50	50 cm	12	38.67
4014.00360K.060.1	15105	Ø 50	60 cm	12	44.67
4014.00360K.080.1	15107	Ø 50	80 cm	12	53.67
4014.0Y360K.020.1	15110	Ø 50	20 cm	12	31.33
4014.0Y360K.033.1	15112	Ø 50	33 cm	12	37.50
4014.0Y360K.040.1	15114	Ø 50	40 cm	12	42.00
4014.0Y360K.050.1	15116	Ø 50	50 cm	12	44.67
4014.0Y360K.060.1	15117	Ø 50	60 cm	12	50.00
4014.0Y360K.080.1	15118	Ø 50	80 cm	12	61.00



* Shower drain / Ø 50 side outlet / Stainless steel Compatible with ceramic frame / Odor blocking by water
 * Душевой канал / Ø 50 боковой выход / Корпус Из Нержавеющей Керамика совместимая / Запах сочных держател
 قنائة دش/ هيكل مقاوم للصدأ / مع مخرج متحرك 36٠ درجة ٥٠ ملم / و غطاء مقاوم للصدأ من اجل السيراميك / مع مانع الروائح الكريهة

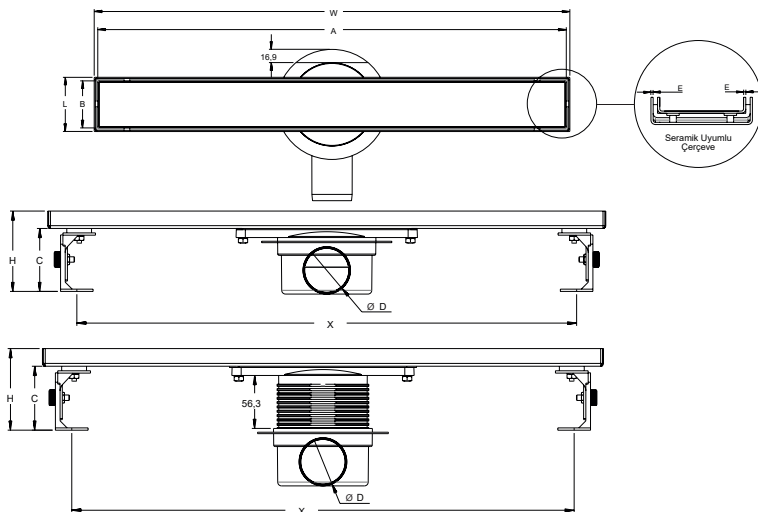

Code	W	L	H	Ø D	A	B	C	X	E
4014.00360K.033.1	330	72	88	49.5	316	58	68	285	1.5
4014.00360K.040.1	400	72	88	49.5	388	58	68	335	1.5
4014.00360K.050.1	500	72	88	49.5	487	58	68	435	1.5
4014.00360K.060.1	600	72	88	49.5	589	58	68	556	1.5
4014.00360K.080.1	785	72	88	49.5	773	58	68	737	1.5
Code	W	L	H	Ø D	A	B	C	X	E
4014.0Y360K.033.1	330	72	154	49.5	316	58	68	285	1.5
4014.0Y360K.040.1	400	72	154	49.5	388	58	68	335	1.5
4014.0Y360K.050.1	500	72	154	49.5	487	58	68	435	1.5
4014.0Y360K.060.1	600	72	154	49.5	589	58	68	556	1.5
4014.0Y360K.080.1	785	72	154	49.5	773	58	68	737	1.5

Table measure "mm"

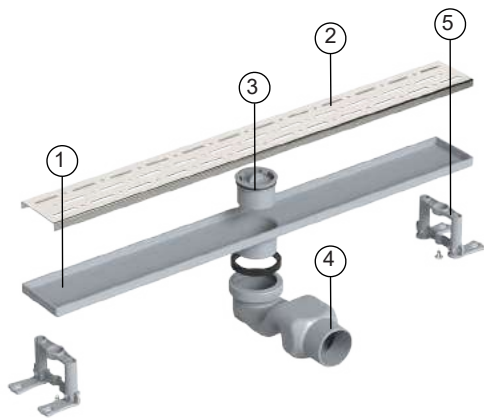

PIECE OF	PARTS DESCRIPTION	MATERIAL	PIECE
4083.1	Paslanmaz Üst Gövde	AISI 304	1
4083.2	Paslanmaz Izgara	AISI 304	1
4083.3	Koku Tutucu	PP	1
4083.4	S Sifon	PP	1
4083.5	Height Ayarlı Montaj Seti	PP	2

STYLE SERIES

Details

DN 50 slide and vertical outlet - compatible with PVC pipe connections, blocking odor by water (36mm). The flow rate is 32 liters/min. Resistant against external chemical effects, operating temperature is between -30°C and +75°C. The grid is made of 304 grade stainless steel.

Advantages

With its 304 grade stainless steel grid, it has a quality and stylish-looking. It can be easily applied at floor. With its odor blocking by water support, it prevents the bad smell coming from the installation. With its adjustable height legs, it can be adjusted depending on the screed concrete. High resistance against the organic and inorganic chemicals, resistant against most acidic and vertically aqueous oxidation.

Areas of Usage

Common use of bathroom shower, hospital and hotel shower areas, locker-room shower areas etc.

Customized Production

Grid patterns can be chosen in gold, bronze or other optional colors in accordance with your desire.

Warning

It is not recommended to use high-density cleaners for a long time.

Code Smart Code Outlet Size Price \$ SIMPLE LINE

4080.0A050K.033.1	15119	Ø 50	33 cm	12	9.68
4080.0A050K.040.1	15148	Ø 50	40 cm	12	11.67
4080.0A050K.050.1	15162	Ø 50	50 cm	12	14.67
4080.0A050K.060.1	15199	Ø 50	60 cm	12	15.67
4080.0A050K.080.1	15216	Ø 50	80 cm	12	18.67

* Shower drain / Ø 50 vertical outlet / Plastic body / Stainless grid / Odor blocking by water
 * Душевой канал / Ø 50 Нижний выход / пластичное тело / Нержавеющая решетка / Гидрозатвор
 قنّاة دش / هيكل بلاستيكي / مع مخرج ٥٠ ملم / و شبكة مقاومه للصدأ / مع مانع الروائح الكريهة



Code Smart Code Outlet Size Price \$ LINE

4081.0Y050K.033.1	15160	Ø 50	33 cm	12	13.33
4081.0Y050K.040.1	15172	Ø 50	40 cm	12	14.67
4081.0Y050K.050.1	15187	Ø 50	50 cm	12	16.67
4081.0Y050K.060.1	15197	Ø 50	60 cm	12	18.67
4081.0Y050K.080.1	15213	Ø 50	80 cm	12	21.67

* Shower drain / Ø 50 horizontal outlet / Plastic body / Stainless grid / Odor blocking by water
 * Душевой канал / Ø 50 Боковой выход / пластичное тело / Нержавеющая решетка / Гидрозатвор
 قنّاة دش / هيكل بلاستيكي / مع مخرج متحرك ٣٦٠ درجة ٥٠ ملم / و شبكة مقاومه للصدأ / مع مانع الروائح الكريهة



Code Smart Code Outlet Size Price \$ STYLE SIFONIK

4083.0Y050K.033.1	15243	Ø 50	33 cm	12	12.33
4083.0Y050K.040.1	15270	Ø 50	40 cm	12	14.66
4083.0Y050K.050.1	15282	Ø 50	50 cm	12	16.67
4083.0Y050K.060.1	15300	Ø 50	60 cm	12	18.67
4083.0Y050K.080.1	15312	Ø 50	80 cm	12	22.00

* Shower drain / Ø 50 horizontal outlet / Plastic body / Stainless grid / Odor blocking by water
 * Душевой канал / Ø 50 Боковой выход / пластичное тело / Нержавеющая решетка / Гидрозатвор
 قنّاة دش / هيكل بلاستيكي / مع مخرج متحرك ٣٦٠ درجة ٥٠ ملم / و شبكة مقاومه للصدأ / مع مانع الروائح الكريهة

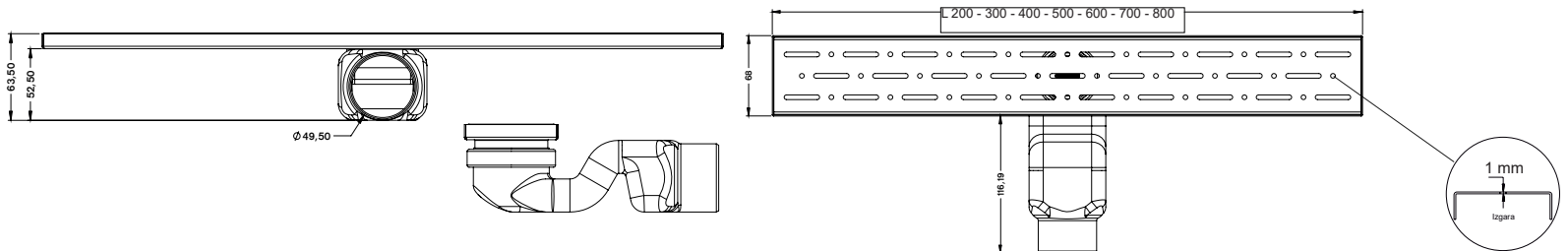

SIMPLE LEGAL

Code	Smart Code	Outlet	Size		Price \$
4086.0A050K.020.1	15329	Ø 50	20 cm	12	14.67
4086.0A050K.033.1	15338	Ø 50	33 cm	12	17.67
4086.0A050K.040.1	15347	Ø 50	40 cm	12	21.00
4086.0A050K.050.1	15363	Ø 50	50 cm	12	24.33
4086.0A050K.060.1	15381	Ø 50	60 cm	12	28.00
4086.0A050K.080.1	15420	Ø 50	80 cm	12	34.67



* Shower drain / Ø 50 vertical outlet / Stainless body / Stainless grid / Odor blocking by water
 * Душевой канал / Ø 50 Нижний выход / Нержавеющее тело / Нержавеющая решетка / Гидрозатвор
 قنارة دش / هيكل مقاوم للصدأ / مع مخرج ٥٠ ملم / و شبكة مقاومه للصدأ / مع مانع الروائح الكريهة

LEGAL

Code	Smart Code	Outlet	Size		Price \$
4087.0Y050K.020.1	15445	Ø 50	20 cm	12	17.00
4087.0Y050K.033.1	15471	Ø 50	33 cm	12	19.67
4087.0Y050K.040.1	15490	Ø 50	40 cm	12	23.33
4087.0Y050K.050.1	15508	Ø 50	50 cm	12	26.67
4087.0Y050K.060.1	15532	Ø 50	60 cm	12	30.00
4087.0Y050K.080.1	15580	Ø 50	80 cm	12	37.33



* Shower drain / Ø 50 horizontal outlet / Stainless body / Stainless grid / Odor blocking by water
 * Душевой канал / Ø 50 Боковой выход / Нержавеющее тело / Нержавеющая решетка / Гидрозатвор
 قنارة دش / هيكل مقاوم للصدأ / مع مخرج متحرك ٣٦٠ درجة ٥٠ ملم / و شبكة مقاومه للصدأ / مع مانع الروائح الكريهة

4088.0A050K.020.1	15321	Ø 50	20 cm	12	17.00
4088.0A050K.033.1	15366	Ø 50	33 cm	12	19.67
4088.0A050K.040.1	15383	Ø 50	40 cm	12	23.33
4088.0A050K.050.1	15396	Ø 50	50 cm	12	26.67
4088.0A050K.060.1	15417	Ø 50	60 cm	12	30.00
4088.0A050K.080.1	15446	Ø 50	80 cm	12	37.33

* Shower drain / Ø 50 vertical outlet / Stainless body / Stainless grid / Odor blocking by water
 * Душевой канал / Ø 50 Нижний выход / Нержавеющее тело / Нержавеющая решетка / Гидрозатвор
 قنارة دش / هيكل مقاوم للصدأ / مع مخرج ٥٠ ملم / و شبكة مقاومه للصدأ / مع مانع الروائح الكريهة



LEGAL SIFONIK

Code	Smart Code	Outlet	Size		Price \$
4084.0Y050K.020.1	15457	Ø 50	20 cm	12	16.33
4084.0Y050K.033.1	15479	Ø 50	33 cm	12	19.18
4084.0Y050K.040.1	15495	Ø 50	40 cm	12	22.67
4084.0Y050K.050.1	15517	Ø 50	50 cm	12	26.00
4084.0Y050K.060.1	15536	Ø 50	60 cm	12	30.00
4084.0Y050K.080.1	15565	Ø 50	80 cm	12	36.67

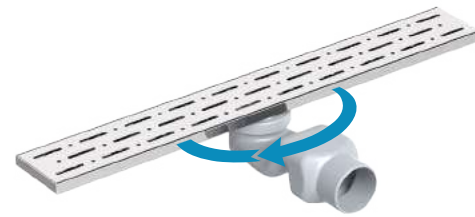

* Shower drain / Ø 50 horizontal outlet / Stainless body / Stainless grid / Odor blocking by water
 * Душевой канал / Ø 50 Боковой выход / Нержавеющее тело / Нержавеющая решетка / Гидрозатвор
 قنارة دش / هيكل مقاوم للصدأ / مع مخرج متحرك ٣٦٠ درجة ٥٠ ملم / و شبكة مقاومه للصدأ / مع مانع الروائح الكريهة



Code Smart Code Outlet Size Price \$ LINE MESH

4092.FY050K.033.1	15585	Ø 50	33 cm	12	14.33
4092.FY050K.040.1	15603	Ø 50	40 cm	12	16.00
4092.FY050K.050.1	15623	Ø 50	50 cm	12	17.67
4092.FY050K.060.1	15637	Ø 50	60 cm	12	20.00
4092.FY050K.080.1	15647	Ø 50	80 cm	12	23.33

* Shower drain / Ø 50 vertical outlet / Plastic body / Stainless grid / Odor blocking by water
 * Душевой канал / Ø 50 Нижний выход / пластичное тело / Нержавеющая решетка / Гидрозатвор
 قنّاة دش / هيكل بلاستيكي / مع مخرج متحرك ٣٦٠ درجة ٥٠ ملم / و شبكة مقاومه للصدأ / مع مانع الروائح الكريهة

4093.FA050K.033.1	15591	Ø 50	33 cm	12	14.33
4093.FA050K.040.1	15613	Ø 50	40 cm	12	16.00
4093.FA050K.050.1	15635	Ø 50	50 cm	12	17.67
4093.FA050K.060.1	15662	Ø 50	60 cm	12	20.00
4093.FA050K.080.1	15698	Ø 50	80 cm	12	23.33

* Shower drain / Ø 50 horizontal outlet / Plastic body / Stainless grid / Odor blocking by water
 * Душевой канал / Ø 50 Боковой выход / пластичное тело / Нержавеющая решетка / Гидрозатвор
 قنّاة دش / هيكل بلاستيكي / مع مخرج ٥٠ ملم / و شبكة مقاومه للصدأ / مع مانع الروائح الكريهة



Code Smart Code Outlet Size Price \$ LEGAL MESH

4094.FY050K.020.1	15665	Ø 50	20 cm	12	22.33
4094.FY050K.033.1	15680	Ø 50	33 cm	12	26.67
4094.FY050K.040.1	15692	Ø 50	40 cm	12	30.00
4094.FY050K.050.1	15706	Ø 50	50 cm	12	34.00
4094.FY050K.060.1	15731	Ø 50	60 cm	12	37.67
4094.FY050K.070.1	15756	Ø 50	70 cm	12	42.00
4094.FY050K.080.1	15784	Ø 50	80 cm	12	45.00

* Shower drain / Ø 50 vertical outlet / Stainless body / Stainless grid / Odor blocking by water
 * Душевой канал / Ø 50 Нижний выход / Нержавеющее тело / Нержавеющая решетка / Гидрозатвор
 قنّاة دش / هيكل مقاوم للصدأ / مع مخرج متحرك ٣٦٠ درجة ٥٠ ملم / و شبكة مقاومه للصدأ / مع مانع الروائح الكريهة

4094.FA050K.020.1	15714	Ø 50	20 cm	12	22.33
4094.FA050K.033.1	15728	Ø 50	33 cm	12	26.67
4094.FA050K.040.1	15740	Ø 50	40 cm	12	30.00
4094.FA050K.050.1	15754	Ø 50	50 cm	12	34.00
4094.FA050K.060.1	15767	Ø 50	60 cm	12	37.67
4094.FA050K.070.1	19335	Ø 50	70 cm	12	42.00
4094.FA050K.080.1	15793	Ø 50	80 cm	12	45.00

* Shower drain / Ø 50 horizontal outlet / Stainless body / Stainless grid / Odor blocking by water
 * Душевой канал / Ø 50 Боковой выход / Нержавеющее тело / Нержавеющая решетка / Гидрозатвор
 قنّاة دش / هيكل مقاوم للصدأ / مع مخرج ٥٠ ملم / و شبكة مقاومه للصدأ / مع مانع الروائح الكريهة



Code Smart Code Outlet Size Price \$ ALFA

4060.0A050K.040.1	28913	Ø 50	40 cm	12	20.00
4060.0A050K.050.1	28914	Ø 50	50 cm	12	23.33
4060.0A050K.060.1	28915	Ø 50	60 cm	12	26.67

* Shower drain / Ø 50 vertical outlet / Stainless body / Stainless grid / Odor blocking by water
 * Душевой канал / Ø 50 Нижний выход / Нержавеющее тело / Нержавеющая решетка / Гидрозатвор
 قنّاة دش / هيكل مقاوم للصدأ / مع مخرج يعرض ١٠ سم / و شبكة مقاومه للصدأ / مع مانع الروائح الكريهة

4060.0Y050K.040.1	28919	Ø 50	40 cm	12	23.33
4060.0Y050K.050.1	28920	Ø 50	50 cm	12	26.67
4060.0Y050K.060.1	28921	Ø 50	60 cm	12	30.00

* Shower drain / Ø 50 horizontal outlet / Stainless body / Stainless grid / Odor blocking by water
 * Душевой канал / Ø 50 Боковой выход / Нержавеющее тело / Нержавеющая решетка / Гидрозатвор
 قنّاة دش / هيكل مقاوم للصدأ / مع مخرج يعرض ١٠ سم / و شبكة مقاومه للصدأ / مع مانع الروائح الكريهة



DELUXE

Code	Smart Code	Outlet	Size	Icon	Price \$
4061.0A050K.040.1	28916	Ø 50	40 cm	12	23.33
4061.0A050K.050.1	28917	Ø 50	50 cm	12	26.67
4061.0A050K.060.1	28918	Ø 50	60 cm	12	31.00

* Shower drain / Ø 50 vertical outlet / Stainless body / Stainless grid / Odor blocking by water
 * Душевой канал / Ø 50 Нижний выход / Нержавеющее тело / Нержавеющая решетка / Гидрозатвор
 قنطرة دش / هيكل مقاوم للصدأ / مع مخرج ٥٠ ملم يعرض ١٢ سم / و شبكة مقاومه للصدأ / مع مانع الروائح الكريهة

Code	Smart Code	Outlet	Size	Icon	Price \$
4061.0Y050K.040.1	28922	Ø 50	40 cm	12	26.67
4061.0Y050K.050.1	28923	Ø 50	50 cm	12	30.00
4061.0Y050K.060.1	28924	Ø 50	60 cm	12	34.00

* Shower drain / Ø 50 horizontal outlet / Stainless body / Stainless grid / Odor blocking by water
 * Душевой канал / Ø 50 Боковой выход / Нержавеющее тело / Нержавеющая решетка / Гидрозатвор
 قنطرة دش / هيكل مقاوم للصدأ / مع مخرج ٥٠ ملم يعرض ١٢ سم / و شبكة مقاومه للصدأ / مع مانع الروائح الكريهة



VEGA

Code	Smart Code	Outlet	Size	Icon	Price \$
4074.0A050K.040.1	15802	Ø 50	40 cm	12	19.17
4074.0A050K.050.1	15812	Ø 50	50 cm	12	21.67
4074.0A050K.060.1	15821	Ø 50	60 cm	12	23.67

* Shower drain / Ø 50 vertical outlet / Stainless body / Stainless grid / Odor blocking by water
 * Душевой канал / Ø 50 Нижний выход / Нержавеющее тело / Нержавеющая решетка / Гидрозатвор
 قنطرة دش / هيكل مقاوم للصدأ / مع مخرج ٥٠ ملم يعرض ١٢ سم / و شبكة مقاومه للصدأ / مع مانع الروائح الكريهة



VEGA

Code	Smart Code	Outlet	Size	Icon	Price \$
4075.0Y050K.040.1	15830	Ø 50	40 cm	12	23.00
4075.0Y050K.050.1	15843	Ø 50	50 cm	12	24.16
4075.0Y050K.060.1	15858	Ø 50	60 cm	12	26.67

* Shower drain / Ø 50 horizontal outlet / Stainless body / Stainless grid / Odor blocking by water
 * Душевой канал / Ø 50 Боковой выход / Нержавеющее тело / Нержавеющая решетка / Гидрозатвор
 قنطرة دش / هيكل مقاوم للصدأ / مع مخرج متحرك ٣٦٠ درجة ٥٠ ملم / و شبكة مقاومه للصدأ / مع مانع الروائح الكريهة

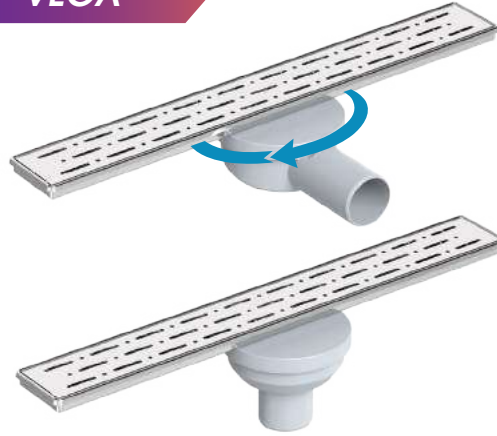

Code	Smart Code	Outlet	Size	Icon	Price \$
4075.0A050K.040.1	15835	Ø 50	40 cm	12	23.00
4075.0A050K.050.1	15856	Ø 50	50 cm	12	24.16
4075.0A050K.060.1	15871	Ø 50	60 cm	12	26.67

* Shower drain / Ø 50 vertical outlet / Stainless body / Stainless grid / Odor blocking by water
 * Душевой канал / Ø 50 Нижний выход / Нержавеющее тело / Нержавеющая решетка / Гидрозатвор
 قنطرة دش / هيكل مقاوم للصدأ / مع مخرج ٥٠ ملم / و شبكة مقاومه للصدأ / مع مانع الروائح الكريهة

VEGA SIFONIK

Code	Smart Code	Outlet	Size	Icon	Price \$
4076.0Y050K.040.1	15882	Ø 50	40 cm	12	20.67
4076.0Y050K.050.1	15911	Ø 50	50 cm	12	22.33
4076.0Y050K.060.1	15925	Ø 50	60 cm	12	24.67

* Shower drain / Ø 50 horizontal outlet / Stainless body / Stainless grid / Odor blocking by water
 * Душевой канал / Ø 50 Боковой выход / Нержавеющее тело / Нержавеющая решетка / Гидрозатвор
 قنطرة دش / هيكل مقاوم للصدأ / مع مخرج متحرك ٣٦٠ درجة ٥٠ ملم / و شبكة مقاومه للصدأ / مع مانع الروائح الكريهة



VEGA LUX

Code	Smart Code	Outlet	Size	Icon	Price \$
4077.0A050K.040.1	15886	Ø 50	40 cm	12	23.00
4077.0A050K.050.1	15901	Ø 50	50 cm	12	25.67
4077.0A050K.060.1	15917	Ø 50	60 cm	12	28.00

* Shower drain / Ø 50 vertical outlet / Stainless body / Stainless grid / Odor blocking by water
 * Душевой канал / Ø 50 Нижний выход / Нержавеющее тело / Нержавеющая решетка / Гидрозатвор / قنّاءة دش / هيكل مقاوم للصدأ / مع مخرج ٥٠ ملم بعرض ١٠ سم / و شبكة مقاومه للصدأ / مع مانع الروائح الكريهة



VEGA LUX

Code	Smart Code	Outlet	Size	Icon	Price \$
4078.0Y050K.040.1	15935	Ø 50	40 cm	12	25.67
4078.0Y050K.050.1	15952	Ø 50	50 cm	12	28.33
4078.0Y050K.060.1	15961	Ø 50	60 cm	12	32.00

* Shower drain / Ø 50 horizontal outlet / Stainless body / Stainless grid / Odor blocking by water
 * Душевой канал / Ø 50 Боковой выход / Нержавеющее тело / Нержавеющая решетка / Гидрозатвор / قنّاءة دش / هيكل مقاوم للصدأ / مع مخرج ٣٦ درجه ٥٠ ملم بعرض ١٠ سم / و شبكة مقاومه للصدأ / مع مانع الروائح الكريهة

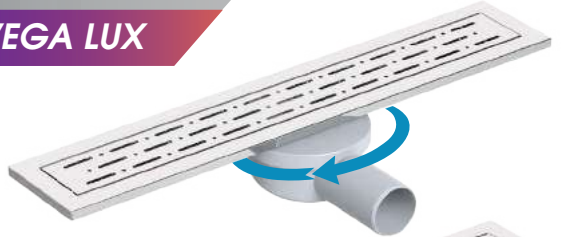

Code	Smart Code	Outlet	Size	Icon	Price \$
4078.0A050K.040.1	15943	Ø 50	40 cm	12	25.67
4078.0A050K.050.1	16046	Ø 50	50 cm	12	28.33
4078.0A050K.060.1	16071	Ø 50	60 cm	12	32.00

* Shower drain / Ø 50 vertical outlet / Stainless body / Stainless grid / Odor blocking by water
 * Душевой канал / Ø 50 Нижний выход / Нержавеющее тело / Нержавеющая решетка / Гидрозатвор / قنّاءة دش / هيكل مقاوم للصدأ / مع مخرج ٥٠ ملم بعرض ١٠ سم / و شبكة مقاومه للصدأ / مع مانع الروائح الكريهة

VEGA LUX SIFONIK

Code	Smart Code	Outlet	Size	Icon	Price \$
4079.0Y050K.040.1	15971	Ø 50	40 cm	12	24.00
4079.0Y050K.050.1	15981	Ø 50	50 cm	12	26.33
4079.0Y050K.060.1	15991	Ø 50	60 cm	12	28.66

* Shower drain / Ø 50 horizontal outlet / Stainless body / Stainless grid / Odor blocking by water
 * Душевой канал / Ø 50 Боковой выход / Нержавеющее тело / Нержавеющая решетка / Гидрозатвор / قنّاءة دش / هيكل مقاوم للصدأ / مع مخرج ٣٦ درجه ٥٠ ملم بعرض ١٠ سم / و شبكة مقاومه للصدأ / مع مانع الروائح الكريهة

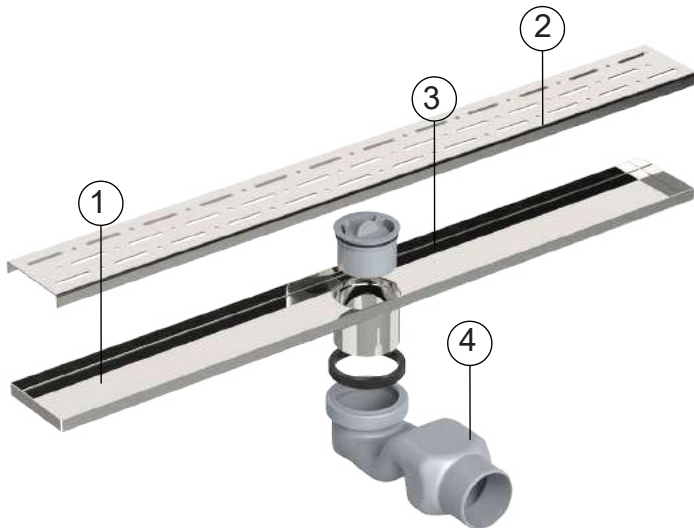

PIECE OF	PARTS DESCRIPTION	MATERIAL	PIECE
4079.1	Paslanmaz Üst Gövde	AISI 304	1
4079.2	Paslanmaz Izgara	AISI 304	1
4079.3	Koku Tutucu	PP	1
4079.4	S Sifon	PP	1



VEGA MESH

Code	Smart Code	Outlet	Size	Price \$
4075.FY050K.040.1	16002	Ø 50	40 cm	25.00
4075.FY050K.050.1	16011	Ø 50	50 cm	28.33
4075.FY050K.060.1	16020	Ø 50	60 cm	31.00

* Shower drain / Ø 50 vertical outlet / Stainless body / Stainless grid / Odor blocking by water
 * Душевой канал / Ø 50 Нижний выход / Нержавеющее тело / Нержавеющая решетка / Гидрозатвор
 قنطرة دش / هيكل مقاوم للصدأ / مع مخرج 36 درجة 50 ملم بعرض 10 سم / و شبكة مقاومه للصدأ / مع مانع الروائح الكريهة

Code	Smart Code	Outlet	Size	Price \$
4075.FA050K.040.1	16031	Ø 50	40 cm	25.00
4075.FA050K.050.1	16051	Ø 50	50 cm	28.33
4075.FA050K.060.1	16066	Ø 50	60 cm	31.00

* Shower drain / Ø 50 horizontal outlet / Stainless body / Stainless grid / Odor blocking by water
 * Душевой канал / Ø 50 Боковой выход / Нержавеющее тело / Нержавеющая решетка / Гидрозатвор
 قنطرة دش / هيكل مقاوم للصدأ / مع مخرج 50 ملم / و شبكة مقاومه للصدأ / مع مانع الروائح الكريهة

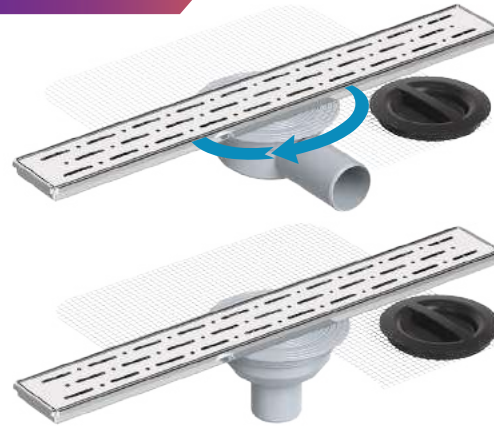

VEGA LUX MESH

Code	Smart Code	Outlet	Size	Price \$
4078.FY050K.040.1	16083	Ø 50	40 cm	30.00
4078.FY050K.050.1	16094	Ø 50	50 cm	32.67
4078.FY050K.060.1	16117	Ø 50	60 cm	35.00

* Shower drain / Ø 50 vertical outlet / Stainless body / Stainless grid / Odor blocking by water
 * Душевой канал / Ø 50 Нижний выход / Нержавеющее тело / Нержавеющая решетка / Гидрозатвор
 قنطرة دش / هيكل مقاوم للصدأ / مع مخرج 36 درجة 50 ملم بعرض 10 سم / و شبكة مقاومه للصدأ / مع مانع الروائح الكريهة

Code	Smart Code	Outlet	Size	Price \$
4078.FA050K.040.1	16086	Ø 50	40 cm	30.00
4078.FA050K.050.1	16109	Ø 50	50 cm	32.67
4078.FA050K.060.1	16143	Ø 50	60 cm	35.00

* Shower drain / Ø 50 horizontal outlet / Stainless body / Stainless grid / Odor blocking by water
 * Душевой канал / Ø 50 Боковой выход / Нержавеющее тело / Нержавеющая решетка / Гидрозатвор
 قنطرة دش / هيكل مقاوم للصدأ / مع مخرج 50 ملم بعرض 10 سم / و شبكة مقاومه للصدأ / مع مانع الروائح الكريهة



Code	Smart Code	Outlet	Size		Price \$	LINE
------	------------	--------	------	--	----------	------

3152.0Y050K.033.1	26499	Ø 50	30 cm	12	12.00	
3152.0Y050K.040.1	26500	Ø 50	40 cm	12	13.33	
3152.0Y050K.050.1	26501	Ø 50	50 cm	12	15.33	
3152.0Y050K.060.1	26502	Ø 50	60 cm	12	16.67	
3152.0Y050K.080.1	26503	Ø 50	80 cm	12	20.00	

* Shower drain / Ø 50 horizontal outlet / Plastic body / Stainless grid / Odor blocking by water
 * Душевой канал / Ø 50 Боковой выход / пластиковое тело / Нержавеющая решетка / Гидрозатвор / قناة دش / هيكل بلاستيكي / مع مخرج ٥٠ ملم / و شبكة مقاومه للصدأ / مع مانع الروائح الكريهة

3152.0A050K.033.1	26494	Ø 50	30 cm	12	12.00
3152.0A050K.040.1	26495	Ø 50	40 cm	12	13.33
3152.0A050K.050.1	26496	Ø 50	50 cm	12	15.33
3152.0A050K.060.1	26497	Ø 50	60 cm	12	16.67
3152.0A050K.080.1	26498	Ø 50	80 cm	12	20.00

* Shower drain / Ø 50 vertical outlet / Plastic body / Stainless grid / Odor blocking by water
 * Душевой канал / Ø 50 Нижний выход / пластиковое тело / Нержавеющая решетка / Гидрозатвор / قناة دش / هيكل بلاستيكي / مع مخرج ٥٠ ملم / و غطاء مقاوم للصدأ / مع مانع الروائح الكريهة

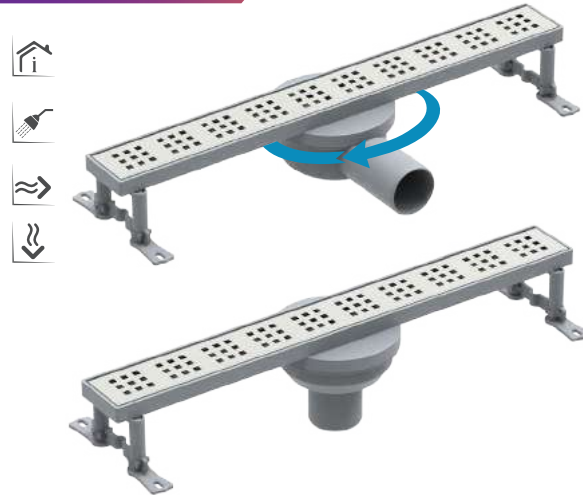

Code	Smart Code	Outlet	Size		Price \$	LINE
------	------------	--------	------	--	----------	------

3153.0Y050K.033.1	26509	Ø 50	30 cm	12	12.00	
3153.0Y050K.040.1	26510	Ø 50	40 cm	12	13.33	
3153.0Y050K.050.1	26511	Ø 50	50 cm	12	15.33	
3153.0Y050K.060.1	26512	Ø 50	60 cm	12	16.67	
3153.0Y050K.080.1	26513	Ø 50	80 cm	12	20.00	

* Shower drain / Ø 50 horizontal outlet / Plastic body / Stainless grid / Odor blocking by water
 * Душевой канал / Ø 50 Боковой выход / пластиковое тело / Нержавеющая решетка / Гидрозатвор / قناة دش / هيكل بلاستيكي / مع مخرج ٥٠ ملم / و غطاء مقاوم للصدأ / من اجل السيراميك / مع مانع الروائح الكريهة

3153.0A050K.033.1	26504	Ø 50	30 cm	12	12.00
3153.0A050K.040.1	26505	Ø 50	40 cm	12	13.33
3153.0A050K.050.1	26506	Ø 50	50 cm	12	15.33
3153.0A050K.060.1	26507	Ø 50	60 cm	12	16.67
3153.0A050K.080.1	26508	Ø 50	80 cm	12	20.00

* Shower drain / Ø 50 vertical outlet / Plastic body / Stainless grid / Odor blocking by water
 * Душевой канал / Ø 50 Нижний выход / пластиковое тело / Нержавеющая решетка / Гидрозатвор / قناة دش / هيكل بلاستيكي / مع مخرج ٥٠ ملم / و غطاء مقاوم للصدأ / من اجل السيراميك / مع مانع الروائح الكريهة

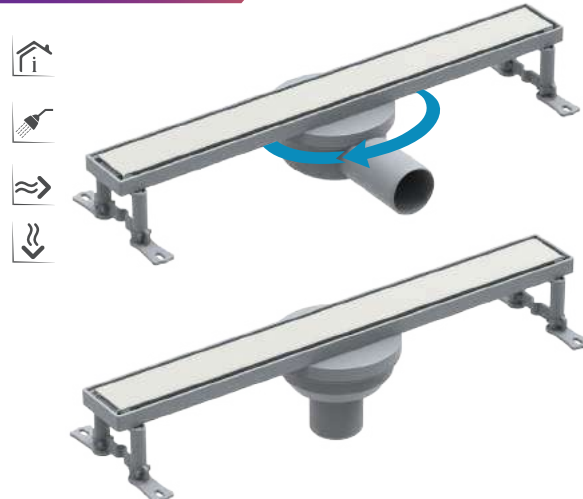

Code	Smart Code	Outlet	Size		Price \$	LINE
------	------------	--------	------	--	----------	------

3154.0Y050K.033.1	26519	Ø 50	30 cm	12	12.00	
3154.0Y050K.040.1	26520	Ø 50	40 cm	12	13.33	
3154.0Y050K.050.1	26521	Ø 50	50 cm	12	15.33	
3154.0Y050K.060.1	26522	Ø 50	60 cm	12	16.67	
3154.0Y050K.080.1	26523	Ø 50	80 cm	12	20.00	

* Shower drain / Ø 50 horizontal outlet / Plastic body / Stainless grid / Odor blocking by water
 * Душевой канал / Ø 50 Боковой выход / пластиковое тело / Нержавеющая решетка / Гидрозатвор / قناة دش / هيكل بلاستيكي / مع مخرج ٥٠ ملم / و غطاء مقاوم للصدأ / من اجل السيراميك / مع مانع الروائح الكريهة

3154.0A050K.033.1	26514	Ø 50	30 cm	12	12.00
3154.0A050K.040.1	26515	Ø 50	40 cm	12	13.33
3154.0A050K.050.1	26516	Ø 50	50 cm	12	15.33
3154.0A050K.060.1	26517	Ø 50	60 cm	12	16.67
3154.0A050K.080.1	26518	Ø 50	80 cm	12	20.00

* Shower drain / Ø 50 vertical outlet / Plastic body / Stainless grid / Odor blocking by water
 * Душевой канал / Ø 50 Нижний выход / пластиковое тело / Нержавеющая решетка / Гидрозатвор / قناة دش / هيكل بلاستيكي / مع مخرج ٥٠ ملم / و غطاء مقاوم للصدأ / من اجل السيراميك / مع مانع الروائح الكريهة



Code	Smart Code	Outlet	Size	Price \$	LINE
------	------------	--------	------	----------	------

3155.0Y050K.033.1	26529	Ø 50	30 cm	12	13.33
3155.0Y050K.040.1	26530	Ø 50	40 cm	12	15.00
3155.0Y050K.050.1	26531	Ø 50	50 cm	12	17.33
3155.0Y050K.060.1	26532	Ø 50	60 cm	12	19.00
3155.0Y050K.080.1	26533	Ø 50	80 cm	12	22.67

* Shower drain / Ø 50 horizontal outlet / Plastic body / Stainless grid / Odor blocking by water
 * Душевой канал / Ø 50 Боковой выход / пластиковое тело / Нержавеющая решетка / Гидрозатвор / قنارة دش / هيكـل بلاستيكي / مع مخرج ٥٠ ملم / و شبكة مقاومه للصدأ / مع مانع الروائح الكريهة



3155.0A050K.033.1	26524	Ø 50	30 cm	12	13.33
3155.0A050K.040.1	26525	Ø 50	40 cm	12	15.00
3155.0A050K.050.1	26526	Ø 50	50 cm	12	17.33
3155.0A050K.060.1	26527	Ø 50	60 cm	12	19.00
3155.0A050K.080.1	26528	Ø 50	80 cm	12	22.67

* Shower drain / Ø 50 vertical outlet / Plastic body / Stainless grid / Odor blocking by water
 * Душевой канал / Ø 50 Нижний выход / пластиковое тело / Нержавеющая решетка / Гидрозатвор / قنارة دش / هيكـل بلاستيكي / مع مخرج ٥٠ ملم / و شبكة مقاومه للصدأ / مع مانع الروائح الكريهة

Code	Smart Code	Outlet	Size	Price \$	LINE MESH
------	------------	--------	------	----------	-----------

3155.FY050K.033.1	27366	Ø 50	30 cm	12	14.00
3155.FY050K.040.1	27367	Ø 50	40 cm	12	15.67
3155.FY050K.050.1	27368	Ø 50	50 cm	12	18.67
3155.FY050K.060.1	37369	Ø 50	60 cm	12	20.00
3155.FY050K.080.1	37370	Ø 50	80 cm	12	23.33

* Shower drain / Ø 50 vertical outlet / Stainless body / Stainless grid / Odor blocking by water
 * Душевой канал / Ø 50 Нижний выход / Нержавеющее тело / Нержавеющая решетка / Гидрозатвор / قنارة دش / هيكـل بلاستيكي / مع مخرج ٥٠ ملم / و شبكة مقاومه للصدأ / مع مانع الروائح الكريهة



3155.FA050K.033.1	27371	Ø 50	30 cm	12	14.00
3155.FA050K.040.1	37372	Ø 50	40 cm	12	15.67
3155.FA050K.050.1	37373	Ø 50	50 cm	12	18.67
3155.FA050K.060.1	37374	Ø 50	60 cm	12	20.00
3155.FA050K.080.1	37375	Ø 50	80 cm	12	23.33

* Shower drain / Ø 50 horizontal outlet / Stainless body / Stainless grid / Odor blocking by water
 * Душевой канал / Ø 50 Боковой выход / Нержавеющее тело / Нержавеющая решетка / Гидрозатвор / قنارة دش / هيكـل بلاستيكي / مع مخرج ٥٠ ملم / و شبكة مقاومه للصدأ / مع مانع الروائح الكريهة

Code	Smart Code	Outlet	Size	Price \$	LINE
------	------------	--------	------	----------	------

3156.0Y050K.033.1	26549	Ø 50	30 cm	12	13.33
3156.0Y050K.040.1	26550	Ø 50	40 cm	12	15.00
3156.0Y050K.050.1	26551	Ø 50	50 cm	12	17.00
3156.0Y050K.060.1	26552	Ø 50	60 cm	12	19.00
3156.0Y050K.080.1	26553	Ø 50	80 cm	12	22.67





* Shower drain / Ø 50 horizontal outlet / Plastic body / Stainless grid / Odor blocking by water
 * Душевой канал / Ø 50 Боковой выход / пластиковое тело / Нержавеющая решетка / Гидрозатвор / قنارة دش / هيكـل بلاستيكي / مع مخرج ٥٠ ملم / و غطاء مقاوم للصدأ من اجل السيراميك / مع مانع الروائح الكريهة



3156.0A050K.033.1	26544	Ø 50	30 cm	12	13.33
3156.0A050K.040.1	26545	Ø 50	40 cm	12	15.00
3156.0A050K.050.1	26546	Ø 50	50 cm	12	17.00
3156.0A050K.060.1	26547	Ø 50	60 cm	12	19.00
3156.0A050K.080.1	26548	Ø 50	80 cm	12	22.67

* Shower drain / Ø 50 vertical outlet / Plastic body / Stainless grid / Odor blocking by water
 * Душевой канал / Ø 50 Нижний выход / пластиковое тело / Нержавеющая решетка / Гидрозатвор / قنارة دش / هيكـل مقاوم للصدأ / مع مخرج ٥٠ ملم / و غطاء مقاوم للصدأ من اجل السيراميك / مع مانع الروائح الكريهة

Code	Smart Code	Outlet	Size		Price \$	LINE
------	------------	--------	------	---	----------	------

3157.0Y050K.033.1	26569	Ø 50	30 cm	12	13.33	   
3157.0Y050K.040.1	26570	Ø 50	40 cm	12	15.00	
3157.0Y050K.050.1	26571	Ø 50	50 cm	12	17.00	
3157.0Y050K.060.1	26572	Ø 50	60 cm	12	19.00	
3157.0Y050K.080.1	26575	Ø 50	80 cm	12	22.67	



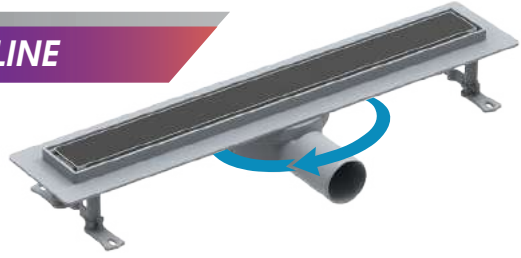

* Shower drain / Ø 50 horizontal outlet / Plastic body / Stainless grid / Odor blocking by water
 * Душ канал / Ø 50 Боковой выход / пластичное тело / Нержавеющая щетка / Гидрозатвор
 قننة دش / هيكل بلاستيكي / مع مخرج ٥٠ ملم / و غطاء مقاوم للصدأ من اجل السيراميك / مع مانع الروائح الكريهة

3157.0A050K.033.1	26564	Ø 50	30 cm	12	13.33
3157.0A050K.040.1	26565	Ø 50	40 cm	12	15.00
3157.0A050K.050.1	26566	Ø 50	50 cm	12	17.00
3157.0A050K.060.1	26567	Ø 50	60 cm	12	19.00
3157.0A050K.080.1	26568	Ø 50	80 cm	12	22.67

* Shower drain / Ø 50 vertical outlet / Plastic body / Stainless grid / Odor blocking by water
 * Душ канал / Ø 50 Нижний выход / пластичное тело / Нержавеющая щетка / Гидрозатвор
 قننة دش / هيكل مقاوم للصدأ / مع مخرج ٥٠ ملم / و غطاء مقاوم للصدأ من اجل السيراميك / مع مانع الروائح الكريهة



Code	Smart Code	Outlet	Size		Price \$	LEGAL
------	------------	--------	------	---	----------	-------

3158.0Y050K.033.1	26595	Ø 50	30 cm	12	19.67	   
3158.0Y050K.040.1	26596	Ø 50	40 cm	12	22.67	
3158.0Y050K.050.1	26597	Ø 50	50 cm	12	26.00	
3158.0Y050K.060.1	26598	Ø 50	60 cm	12	29.00	
3158.0Y050K.080.1	26599	Ø 50	80 cm	12	35.00	

* Shower drain / Ø 50 vertical outlet / Stainless body / Stainless grid / Odor blocking by water
 * Душ канал / Ø 50 Нижний выход / Нержавеющее тело / Нержавеющая щетка / Гидрозатвор
 قننة دش / ٥٠-٥٠ مصرف جانبي / جسم بلاستيكي / شبكة مقاوم للصدأ / حابس رائحة مياه

3158.0A050K.033.1	26587	Ø 50	30 cm	12	19.67
3158.0A050K.040.1	26588	Ø 50	40 cm	12	22.67
3158.0A050K.050.1	26592	Ø 50	50 cm	12	26.00
3158.0A050K.060.1	26593	Ø 50	60 cm	12	29.00
3158.0A050K.080.1	26594	Ø 50	80 cm	12	35.00

* Shower drain / Ø 50 horizontal outlet / Stainless body / Stainless grid / Odor blocking by water
 * Душ канал / Ø 50 Боковой выход / Нержавеющее тело / Нержавеющая щетка / Гидрозатвор
 قننة دش / ٥٠-٥٠ مصرف سفلي / جسم بلاستيكي / شبكة مقاوم للصدأ / حابس رائحة مياه



LEGAL

Code	Smart Code	Outlet	Size	Price \$
3159.0Y050K.033.1	26615	Ø 50	30 cm	12 19.67
3159.0Y050K.040.1	26616	Ø 50	40 cm	12 22.67
3159.0Y050K.050.1	26617	Ø 50	50 cm	12 26.00
3159.0Y050K.060.1	26618	Ø 50	60 cm	12 29.00
3159.0Y050K.080.1	26619	Ø 50	80 cm	12 35.00

* Shower drain / Ø 50 vertical outlet / Stainless body / Stainless grid / Odor blocking by water
 * Душевой канал / Ø 50 Нижний выход / Нержавеющее тело / Нержавеющая решетка / Гидрозатвор / قنارة دش / ٥٠-٥٠ مصرف جانبي / جسم بلاستيكي / شبكة مقاومة للصدأ / حابس رائحة المياه

Code	Smart Code	Outlet	Size	Price \$
3159.0A050K.033.1	26610	Ø 50	30 cm	12 19.67
3159.0A050K.040.1	26611	Ø 50	40 cm	12 22.67
3159.0A050K.050.1	26612	Ø 50	50 cm	12 26.00
3159.0A050K.060.1	26613	Ø 50	60 cm	12 29.00
3159.0A050K.080.1	26614	Ø 50	80 cm	12 35.00

* Shower drain / Ø 50 horizontal outlet / Stainless body / Stainless grid / Odor blocking by water
 * Душевой канал / Ø 50 Боковой выход / Нержавеющее тело / Нержавеющая решетка / Гидрозатвор / قنارة دش / ٥٠-٥٠ مصرف سفلي / جسم بلاستيكي / شبكة مقاومة للصدأ / حابس رائحة المياه



LINE T.M.

Code	Smart Code	Outlet	Size	Price \$
3155.TY050K.033.1	26539	Ø 50	30 cm	12 20.00
3155.TY050K.040.1	26540	Ø 50	40 cm	12 23.33
3155.TY050K.050.1	26541	Ø 50	50 cm	12 27.33
3155.TY050K.060.1	26542	Ø 50	60 cm	12 30.67
3155.TY050K.080.1	26543	Ø 50	80 cm	12 37.00

* Shower drain / Ø 50 side outlet / Plastic body / Stainless grid Textile membrane / Odor blocking by water
 * Душевой канал / Ø 50 боковой выход / пластиковое тело / Нержавеющая решетка / Текстиль Мембраны / Гидрозатвор / قنارة دش / مصرف جانبي / هيكل بلاستيكي / نسيج شبكة مقاومة للصدأ / حابس رائحة المياه

Code	Smart Code	Outlet	Size	Price \$
3155.TA050K.033.1	26534	Ø 50	30 cm	12 20.00
3155.TA050K.040.1	26535	Ø 50	40 cm	12 23.33
3155.TA050K.050.1	26536	Ø 50	50 cm	12 27.33
3155.TA050K.060.1	26537	Ø 50	60 cm	12 30.67
3155.TA050K.080.1	26538	Ø 50	80 cm	12 37.00

* Shower drain / Ø 50 vertical outlet / Plastic body / Stainless grid Textile membrane / Odor blocking by water
 * Душевой канал / Ø 50 Нижний выход / пластиковое тело / Нержавеющая решетка / Текстиль Мембраны / Гидрозатвор / قنارة دش / بمصرف سفلي / هيكل بلاستيكي / نسيج شبكة مقاومة للصدأ / حابس رائحة المياه

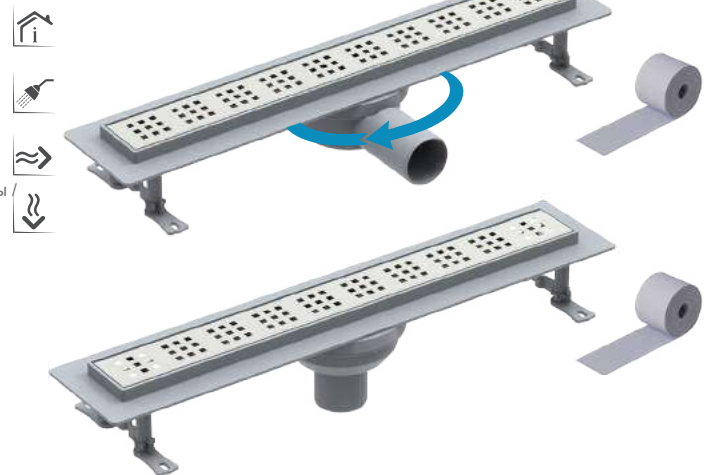

LINE T.M.

Code	Smart Code	Outlet	Size	Price \$
3156.TY050K.033.1	26559	Ø 50	30 cm	12 20.67
3156.TY050K.040.1	26560	Ø 50	40 cm	12 24.33
3156.TY050K.050.1	26561	Ø 50	50 cm	12 28.67
3156.TY050K.060.1	26562	Ø 50	60 cm	12 32.33
3156.TY050K.080.1	26563	Ø 50	80 cm	12 38.67

* Shower drain / Ø 50 side outlet / Plastic body / Stainless grid Textile membrane / Odor blocking by water
 * Душевой канал / Ø 50 боковой выход / пластиковое тело / Нержавеющая решетка / Текстиль Мембраны / Гидрозатвор / قنارة دش / مصرف جانبي / هيكل بلاستيكي / نسيج شبكة مقاومة للصدأ / حابس رائحة المياه

Code	Smart Code	Outlet	Size	Price \$
3156.TA050K.033.1	26554	Ø 50	30 cm	12 20.67
3156.TA050K.040.1	26555	Ø 50	40 cm	12 24.33
3156.TA050K.050.1	26556	Ø 50	50 cm	12 28.67
3156.TA050K.060.1	26557	Ø 50	60 cm	12 32.33
3156.TA050K.080.1	26558	Ø 50	80 cm	12 38.67

* Shower drain / Ø 50 vertical outlet / Plastic body / Stainless grid Textile membrane / Odor blocking by water
 * Душевой канал / Ø 50 Нижний выход / пластиковое тело / Нержавеющая решетка / Текстиль Мембраны / Гидрозатвор / قنارة دش / بمصرف سفلي / هيكل بلاستيكي / نسيج شبكة مقاومة للصدأ / حابس رائحة المياه



Code

Smart Code

Outlet

Size



Price \$

DELUXE

3163.0Y050K.033.1	28952	Ø 50	30 cm	12	25.33
3163.0Y050K.040.1	28953	Ø 50	40 cm	12	28.67
3163.0Y050K.050.1	28954	Ø 50	50 cm	12	32.67
3163.0Y050K.060.1	28955	Ø 50	60 cm	12	37.33
3163.0Y050K.080.1	28956	Ø 50	80 cm	12	45.32

* Shower drain / Ø 50 horizontal outlet / Stainless body / Stainless grid / Odor blocking by water
 * Душевой канал / Ø 50 Боковой выход / Нержавеющее тело / Нержавеющая решетка / Гидрозатвор
 قنّاة دش / هيكل مقاوم للصدأ / مع مخرج ٣٦ درجه ٥٠ ملم يعرض ١٠ سم / و شبكة مقاومه للصدأ / مع مانع الروائح الكريهة



NEW!

3163.0A050K.033.1	28957	Ø 50	30 cm	12	25.33
3163.0A050K.040.1	28958	Ø 50	40 cm	12	28.67
3163.0A050K.050.1	28959	Ø 50	50 cm	12	32.67
3163.0A050K.060.1	28960	Ø 50	60 cm	12	37.33
3163.0A050K.080.1	28961	Ø 50	80 cm	12	45.32

* Shower drain / Ø 50 vertical outlet / Stainless body / Stainless grid / Odor blocking by water
 * Душевой канал / Ø 50 Нижний выход / Нержавеющее тело / Нержавеющая решетка / Гидрозатвор
 قنّاة دش / هيكل مقاوم للصدأ / مع مخرج ٥٠ ملم يعرض ١٠ سم / و شبكة مقاومه للصدأ / مع مانع الروائح الكريهة



Code

Smart Code

Outlet

Size



Price \$

LUX LEGAL

3162.0Y050K.033.1	28942	Ø 50	30 cm	12	20.67
3162.0Y050K.040.1	28943	Ø 50	40 cm	12	23.66
3162.0Y050K.050.1	28944	Ø 50	50 cm	12	27.00
3162.0Y050K.060.1	28945	Ø 50	60 cm	12	30.00
3162.0Y050K.080.1	28946	Ø 50	80 cm	12	36.33

* Shower drain / Ø 50 vertical outlet / Stainless body / Stainless grid / Odor blocking by water
 * Душ канал / Ø 50 Нижний выход / Нержавеющее тело / Нержавеющая щетка / Гидрозатвор
 قنّاة دش / ٥٠٠ مصرف جانبي / جسم بلاستيكي / شبكة مقاوم للصدأ / حابس رائحة مياه



NEW!

3162.0A050K.033.1	28947	Ø 50	30 cm	12	20.67
3162.0A050K.040.1	28948	Ø 50	40 cm	12	23.66
3162.0A050K.050.1	28949	Ø 50	50 cm	12	27.00
3162.0A050K.060.1	28950	Ø 50	60 cm	12	30.00
3162.0A050K.080.1	28951	Ø 50	80 cm	12	36.33

* Shower drain / Ø 50 horizontal outlet / Stainless body / Stainless grid / Odor blocking by water
 * Душ канал / Ø 50 Боковой выход / Нержавеющее тело / Нержавеющая щетка / Гидрозатвор
 قنّاة دش / ٥٠٠ مصرف سفلي / جسم بلاستيكي / شبكة مقاوم للصدأ / حابس رائحة مياه



SHOWER
DRAINS

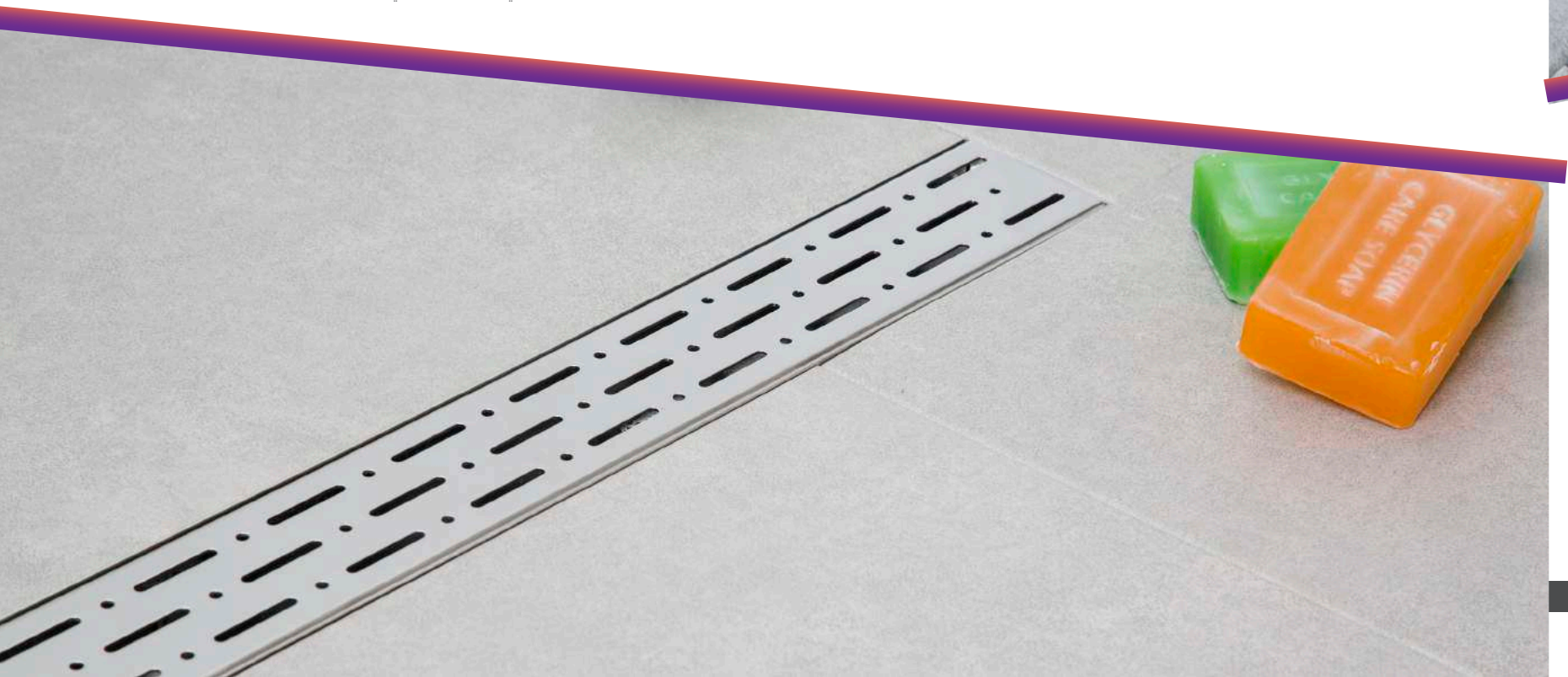

PERA SERIES

Details

DN 50 side and vertical outlet - compatible with PVC pipe connections, blocking odor by water (36mm). The flow rate is 32 liters/min. Resistant against external chemical effects, operating temperature is between -30°C and +75°C. The grid is made of 304 grade stainless steel.

Advantages

With its 304 grade stainless steel grid, it has a quality and stylish-looking. It can be easily applied at floor. With its odor blocking by water support, it prevents the bad smell coming from the installation. With its adjustable height legs, it can be adjusted depending on the screed concrete. High resistance against the organic and inorganic chemicals, resistant against most acidic and vertically aqueous oxidation.

Areas of Usage

Common use of bathroom shower, hospital and hotel shower areas, locker-room shower areas etc.

Customized Production

Grid patterns can be chosen in gold, bronze or other optional colors in accordance with your desire.

Warning

It is not recommended to use high-density cleaners for a long time.

Code Smart Code Outlet Size Price \$ LINE T.M.

3157.TY050K.033.1	26581	Ø 50	30 cm	12	20.67
3157.TY050K.040.1	26582	Ø 50	40 cm	12	24.33
3157.TY050K.050.1	26584	Ø 50	50 cm	12	28.67
3157.TY050K.060.1	26585	Ø 50	60 cm	12	32.33
3157.TY050K.080.1	26586	Ø 50	80 cm	12	38.67

* Shower drain / Ø 50 side outlet / Plastic body / Stainless grid Textile membrane / Odor blocking by water
 * Душевой канал / Ø 50 боковой выход / пластичное тело / Нержавеющая решетка / Текстиль Мембраны / Гидрозатвор
 قناة دش / هيكل بلاستيكي / مع مخرج 50 ملم / و غطاء مقاوم للصدأ من اجل السيراميك / مع مانع الروائح الكريهة



3157.TA050K.033.1	26576	Ø 50	30 cm	12	20.67
3157.TA050K.040.1	26577	Ø 50	40 cm	12	24.33
3157.TA050K.050.1	26578	Ø 50	50 cm	12	28.67
3157.TA050K.060.1	26579	Ø 50	60 cm	12	32.33
3157.TA050K.080.1	26580	Ø 50	80 cm	12	38.67

* Shower drain / Ø 50 vertical outlet / Plastic body / Stainless grid Textile membrane / Odor blocking by water
 * Душевой канал / Ø 50 Нижний выход / пластичное тело / Нержавеющая решетка / Текстиль Мембраны / Гидрозатвор
 قناة دش / هيكل بلاستيكي / مع مخرج 50 ملم / و غطاء مقاوم للصدأ من اجل السيراميك / مع مانع الروائح الكريهة

Code Smart Code Outlet Size Price \$ LEGAL T.M.

3158.TY050K.033.1	26604	Ø 50	30 cm	12	21.33
3158.TY050K.040.1	26605	Ø 50	40 cm	12	25.00
3158.TY050K.050.1	26606	Ø 50	50 cm	12	28.67
3158.TY050K.060.1	26607	Ø 50	60 cm	12	32.33
3158.TY050K.080.1	26608	Ø 50	80 cm	12	39.00

* Shower drain / Ø 50 vertical outlet / Stainless body / Stainless grid / Odor blocking by water
 * Душевой канал / Ø 50 Нижний выход / Нержавеющее тело / Нержавеющая решетка / Гидрозатвор
 قناة دش / هيكل بلاستيكي / مع مخرج 50 ملم / و شبكة مقاومه للصدأ / مع مانع الروائح الكريهة

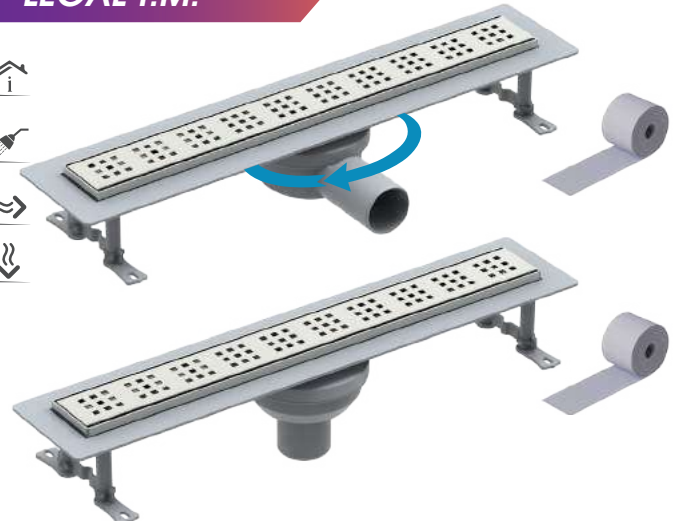

3158.TA050K.033.1	26609	Ø 50	30 cm	12	21.33
3158.TA050K.040.1	26600	Ø 50	40 cm	12	25.00
3158.TA050K.050.1	26601	Ø 50	50 cm	12	28.67
3158.TA050K.060.1	26602	Ø 50	60 cm	12	32.33
3158.TA050K.080.1	26603	Ø 50	80 cm	12	39.00

* Shower drain / Ø 50 horizontal outlet / Stainless body / Stainless grid / Odor blocking by water
 * Душевой канал / Ø 50 Боковой выход / Нержавеющее тело / Нержавеющая решетка / Гидрозатвор
 قناة دش / هيكل بلاستيكي / مع مخرج 50 ملم / و شبكة مقاومه للصدأ / مع مانع الروائح الكريهة

Code Smart Code Outlet Size Price \$ LEGAL T.M.

3159.TY050K.033.1	26625	Ø 50	30 cm	12	21.33
3159.TY050K.040.1	26626	Ø 50	40 cm	12	25.00
3159.TY050K.050.1	26627	Ø 50	50 cm	12	28.67
3159.TY050K.060.1	26628	Ø 50	60 cm	12	32.33
3159.TY050K.080.1	26629	Ø 50	80 cm	12	39.00

* Shower drain / Ø 50 vertical outlet / Stainless body / Stainless grid / Odor blocking by water
 * Душевой канал / Ø 50 Нижний выход / Нержавеющее тело / Нержавеющая решетка / Гидрозатвор
 قناة دش / هيكل مقاوم للصدأ / مع مخرج 50 ملم / و غطاء مقاوم للصدأ من اجل السيراميك / مع مانع الروائح الكريهة



3159.TA050K.033.1	26620	Ø 50	30 cm	12	21.33
3159.TA050K.040.1	26621	Ø 50	40 cm	12	25.00
3159.TA050K.050.1	26622	Ø 50	50 cm	12	28.67
3159.TA050K.060.1	26623	Ø 50	60 cm	12	32.33
3159.TA050K.080.1	26624	Ø 50	80 cm	12	39.00

* Shower drain / Ø 50 horizontal outlet / Stainless body / Stainless grid / Odor blocking by water
 * Душевой канал / Ø 50 Боковой выход / Нержавеющее тело / Нержавеющая решетка / Гидрозатвор
 قناة دش / هيكل مقاوم للصدأ / مع مخرج 50 ملم / و غطاء مقاوم للصدأ من اجل السيراميك / مع مانع الروائح الكريهة

Code	Smart Code	Outlet	Size		Price \$	LINE
------	------------	--------	------	---	----------	------

ALÇAK SEVIYELI

4022.0Y050A.033.1	22310	Ø 50	33 cm	12	16.67
4022.0Y050A.040.1	22382	Ø 50	40 cm	12	18.33
4022.0Y050A.050.1	22391	Ø 50	50 cm	12	21.33
4022.0Y050A.060.1	22400	Ø 50	60 cm	12	24.67
4022.0Y050A.080.1	22409	Ø 50	80 cm	12	26.33

* Shower drain / Ø 50 horizontal outlet / Plastic body / Stainless grid / Odor blocking by water
 * Душевой канал / Ø 50 Боковой выход / пластиковое тело / Нержавеющая решетка / Гидрозатвор
 قنارة دش / هيكل بلاستيكي / مع مخرج 50 ملم / و شبكة مقاومه للصدأ / مع مانع الروائح الكريهة

ALÇAK SEVIYELI

4022.0A050A.033.1	22418	Ø 50	33 cm	12	16.67
4022.0A050A.040.1	22426	Ø 50	40 cm	12	18.33
4022.0A050A.050.1	22435	Ø 50	50 cm	12	21.33
4022.0A050A.060.1	22446	Ø 50	60 cm	12	24.67
4022.0A050A.080.1	22459	Ø 50	80 cm	12	26.33

* Shower drain / Ø 50 vertical outlet / Plastic body / Stainless grid / Odor blocking by water
 * Душевой канал / Ø 50 Нижний выход / пластиковое тело / Нержавеющая решетка / Гидрозатвор
 قنارة دش / هيكل بلاستيكي / مع مخرج 50 ملم / و شبكة مقاومه للصدأ / مع مانع الروائح الكريهة



Code	Smart Code	Outlet	Size		Price \$	LINE
------	------------	--------	------	---	----------	------

4022.0Y050K.033.1	16126	Ø 50	33 cm	12	16.67
4022.0Y050K.040.1	16138	Ø 50	40 cm	12	18.33
4022.0Y050K.050.1	16157	Ø 50	50 cm	12	21.33
4022.0Y050K.060.1	16168	Ø 50	60 cm	12	24.67
4022.0Y050K.080.1	16178	Ø 50	80 cm	12	26.33

* Shower drain / Ø 50 horizontal outlet / Plastic body / Stainless grid / Odor blocking by water
 * Душевой канал / Ø 50 Боковой выход / пластиковое тело / Нержавеющая решетка / Гидрозатвор
 قنارة دش / هيكل بلاستيكي / مع مخرج 50 ملم / و شبكة مقاومه للصدأ / مع مانع الروائح الكريهة

4022.0A050K.033.1	16159	Ø 50	33 cm	12	16.67
4022.0A050K.040.1	16187	Ø 50	40 cm	12	18.33
4022.0A050K.050.1	16207	Ø 50	50 cm	12	21.33
4022.0A050K.060.1	16231	Ø 50	60 cm	12	24.67
4022.0A050K.080.1	16249	Ø 50	80 cm	12	26.33

* Shower drain / Ø 50 vertical outlet / Plastic body / Stainless grid / Odor blocking by water
 * Душевой канал / Ø 50 Нижний выход / пластиковое тело / Нержавеющая решетка / Гидрозатвор
 قنارة دش / هيكل بلاستيكي / مع مخرج 50 ملم / و شبكة مقاومه للصدأ / مع مانع الروائح الكريهة



Code	Smart Code	Outlet	Size		Price \$	LINE GOLD
------	------------	--------	------	---	----------	-----------

4022.0Y050G.033.1	16198	Ø 50	33 cm	12	24.67
4022.0Y050G.040.1	16217	Ø 50	40 cm	12	26.67
4022.0Y050G.050.1	16233	Ø 50	50 cm	12	31.00
4022.0Y050G.060.1	16252	Ø 50	60 cm	12	38.00
4022.0Y050G.080.1	16352	Ø 50	80 cm	12	40.67

* Shower drain / Ø 50 horizontal outlet / Plastic body / Stainless grid / Odor blocking by water
 * Душевой канал / Ø 50 Боковой выход / пластиковое тело / Нержавеющая решетка / Гидрозатвор
 قنارة دش / هيكل بلاستيكي / مع مخرج 50 ملم / و شبكة مقاومه للصدأ / مع مانع الروائح الكريهة

4022.0A050G.033.1	16264	Ø 50	33 cm	12	24.67
4022.0A050G.040.1	16291	Ø 50	40 cm	12	26.67
4022.0A050G.050.1	16314	Ø 50	50 cm	12	31.00
4022.0A050G.060.1	16331	Ø 50	60 cm	12	38.00
4022.0A050G.080.1	16349	Ø 50	80 cm	12	40.67

* Shower drain / Ø 50 vertical outlet / Plastic body / Stainless grid / Odor blocking by water
 * Душевой канал / Ø 50 Нижний выход / пластиковое тело / Нержавеющая решетка / Гидрозатвор
 قنارة دش / هيكل بلاستيكي / مع مخرج 50 ملم / و شبكة مقاومه للصدأ / مع مانع الروائح الكريهة



Code Smart Code Outlet Size Price \$ LINE T.M.

Code	Smart Code	Outlet	Size	Price \$
4022.TY050K.033.1	16268	Ø 50	33 cm	12 18.33
4022.TY050K.040.1	16283	Ø 50	40 cm	12 19.67
4022.TY050K.050.1	16298	Ø 50	50 cm	12 22.67
4022.TY050K.060.1	16312	Ø 50	60 cm	12 26.67
4022.TY050K.080.1	16332	Ø 50	80 cm	12 29.33

* Shower drain / Ø 50 side outlet / Plastic body / Stainless grid Textile membrane / Odor blocking by water
 * Душевой канал / Ø 50 боковой выход / пластичное тело / Нержавеющая решетка / Текстиль Мембраны / Гидрозатвор
 قنارة دش / هيكل بلاستيكي / مع مخرج ٥٠ ملم / و شبكة مقاومه للصدأ / مع مانع الروائح الكريهة

Code	Smart Code	Outlet	Size	Price \$
4022.TA050K.033.1	16363	Ø 50	33 cm	12 18.33
4022.TA050K.040.1	16395	Ø 50	40 cm	12 19.67
4022.TA050K.050.1	16413	Ø 50	50 cm	12 22.67
4022.TA050K.060.1	16436	Ø 50	60 cm	12 26.67
4022.TA050K.080.1	16451	Ø 50	80 cm	12 29.33

* Shower drain / Ø 50 vertical outlet / Plastic body / Stainless grid Textile membrane / Odor blocking by water
 * Душевой канал / Ø 50 Нижний выход / пластичное тело / Нержавеющая решетка / Текстиль Мембраны / Гидрозатвор
 قنارة دش / هيكل بلاستيكي / مع مخرج ٥٠ ملم / و شبكة مقاومه للصدأ / مع مانع الروائح الكريهة



Code Smart Code Outlet Size Price \$ LINE T.M.GOLD

Code	Smart Code	Outlet	Size	Price \$
4022.TY050G.033.1	16369	Ø 50	33 cm	12 26.67
4022.TY050G.040.1	16386	Ø 50	40 cm	12 28.33
4022.TY050G.050.1	16398	Ø 50	50 cm	12 31.00
4022.TY050G.060.1	16416	Ø 50	60 cm	12 37.67
4022.TY050G.080.1	16430	Ø 50	80 cm	12 41.33

* Shower drain / Ø 50 side outlet / Plastic body / Stainless grid Textile membrane / Odor blocking by water
 * Душевой канал / Ø 50 боковой выход / пластичное тело / Нержавеющая решетка / Текстиль Мембраны / Гидрозатвор
 قنارة دش / هيكل بلاستيكي / مع مخرج ٥٠ ملم / و شبكة مقاومه للصدأ / مع مانع الروائح الكريهة

Code	Smart Code	Outlet	Size	Price \$
4022.TA050G.033.1	16446	Ø 50	33 cm	12 26.67
4022.TA050G.040.1	16469	Ø 50	40 cm	12 28.33
4022.TA050G.050.1	16495	Ø 50	50 cm	12 31.00
4022.TA050G.060.1	16516	Ø 50	60 cm	12 37.67
4022.TA050G.080.1	16543	Ø 50	80 cm	12 41.33

* Shower drain / Ø 50 vertical outlet / Plastic body / Stainless grid Textile membrane / Odor blocking by water
 * Душевой канал / Ø 50 Нижний выход / пластичное тело / Нержавеющая решетка / Текстиль Мембраны / Гидрозатвор
 قنارة دش / هيكل بلاستيكي / مع مخرج ٥٠ ملم / و شبكة مقاومه للصدأ / مع مانع الروائح الكريهة



SHOWER
DRAINS

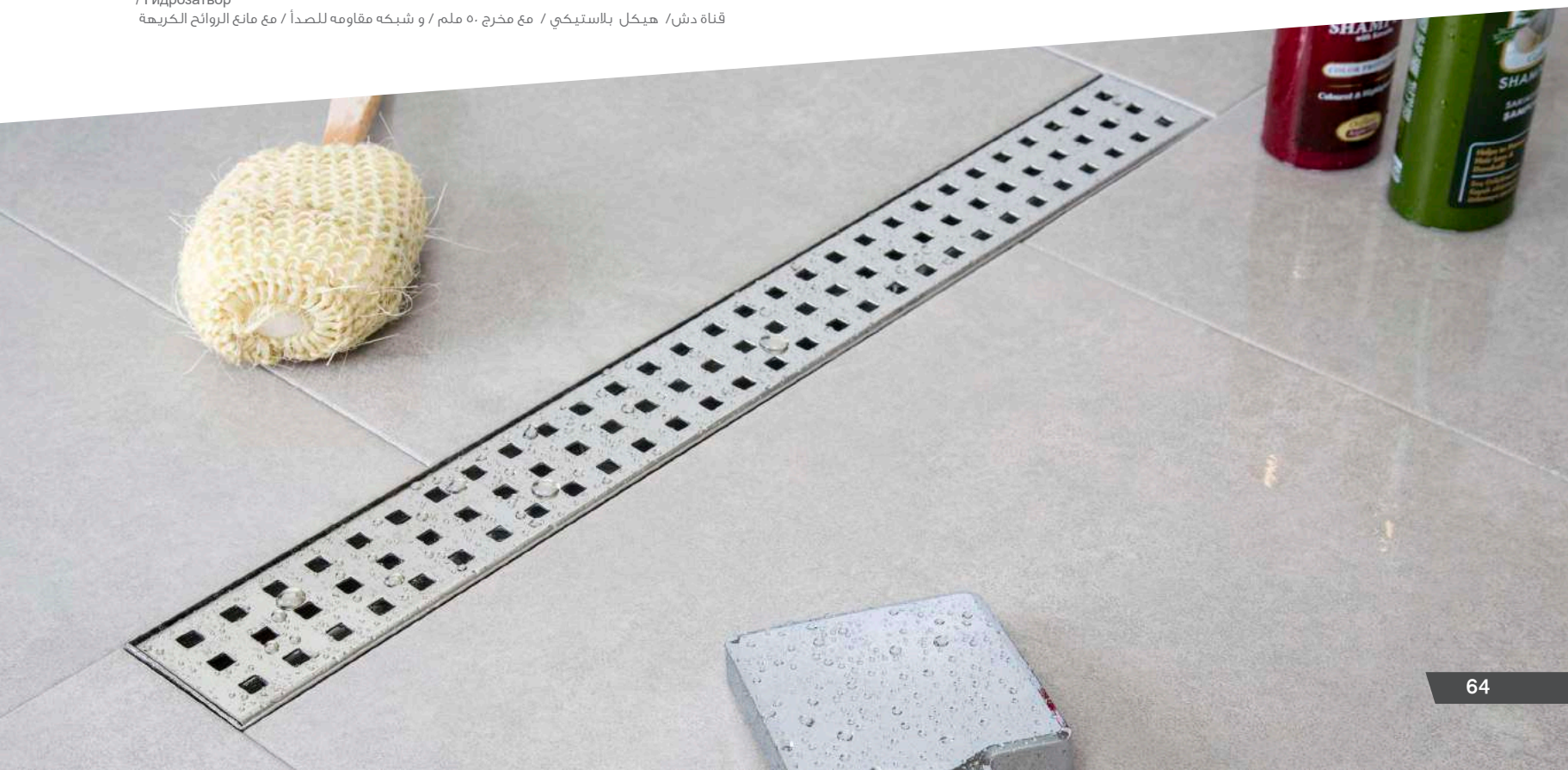

Code Smart Code Outlet Size Price \$ DELUXE

4016.0Y050K.033.1	16462	Ø 50	33 cm	12	24.67
4016.0Y050K.040.1	16486	Ø 50	40 cm	12	26.00
4016.0Y050K.050.1	16497	Ø 50	50 cm	12	30.33
4016.0Y050K.060.1	16512	Ø 50	60 cm	12	34.33
4016.0Y050K.080.1	16527	Ø 50	80 cm	12	41.34

* Shower drain / Ø 50 horizontal outlet / Stainless body / Stainless grid / Odor blocking by water
 * Душевой канал / Ø 50 Боковой выход / Нержавеющее тело / Нержавеющая решетка / Гидрозатвор
 قنارة دش / هيكل بلاستيكي / مع مخرج ٥٠ ملم / و شبكة مقاومه للصدأ / مع مانع الروائح الكريهة

4016.0A050K.033.1	16542	Ø 50	33 cm	12	24.67
4016.0A050K.040.1	16570	Ø 50	40 cm	12	26.00
4016.0A050K.050.1	16592	Ø 50	50 cm	12	30.33
4016.0A050K.060.1	16608	Ø 50	60 cm	12	34.33
4016.0A050K.080.1	16625	Ø 50	80 cm	12	41.34

* Shower drain / Ø 50 vertical outlet / Stainless body / Stainless grid / Odor blocking by water
 * Душевой канал / Ø 50 Нижний выход / Нержавеющее тело / Нержавеющая решетка / Гидрозатвор
 قنارة دش / هيكل بلاستيكي / مع مخرج ٥٠ ملم / و شبكة مقاومه للصدأ / مع مانع الروائح الكريهة



Code Smart Code Outlet Size Price \$ DELUXE T.M.

4016.TY050K.033.1	16555	Ø 50	33 cm	12	26.00
4016.TY050K.040.1	16572	Ø 50	40 cm	12	28.00
4016.TY050K.050.1	16587	Ø 50	50 cm	12	32.33
4016.TY050K.060.1	16604	Ø 50	60 cm	12	36.33
4016.TY050K.080.1	16634	Ø 50	80 cm	12	44.00

* Shower drain / Ø 50 side outlet / Plastic body / Stainless grid Stainless frame / Textile membrane / Odor blocking by water
 * Душевой канал / Ø 50 боковой выход / пластиковое тело / Нержавеющая решетка / Текстиль Мембраны / Гидрозатвор
 قنارة دش / هيكل بلاستيكي / مع مخرج ٥٠ ملم / و شبكة مقاومه للصدأ / مع مانع الروائح الكريهة

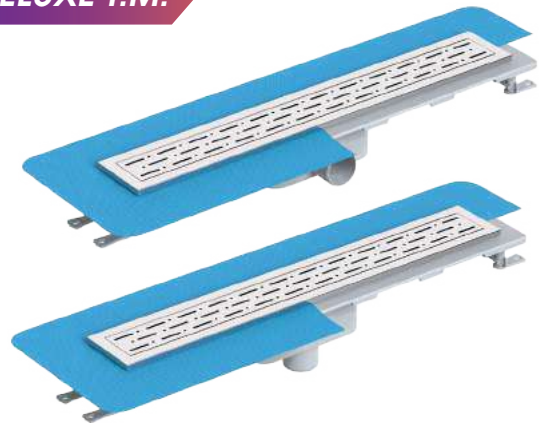

4016.TA050K.033.1	16643	Ø 50	33 cm	12	26.00
4016.TA050K.040.1	16666	Ø 50	40 cm	12	28.00
4016.TA050K.050.1	16683	Ø 50	50 cm	12	32.33
4016.TA050K.060.1	16704	Ø 50	60 cm	12	36.33
4016.TA050K.080.1	16722	Ø 50	80 cm	12	44.00

* Shower drain / Ø 50 vertical outlet / Plastic body / Odor blocking by water Stainless frame / Textile membrane / Odor blocking by water
 * Душевой канал / Ø 50 Нижний выход / пластиковое тело / Нержавеющая решетка / Текстиль Мембраны / Гидрозатвор
 قنارة دش / هيكل بلاستيكي / مع مخرج ٥٠ ملم / و شبكة مقاومه للصدأ / مع مانع الروائح الكريهة

PIECE OF	PARTS DESCRIPTION	MATERIAL	PIECE
4016.1	Plastik Vertical Gövde	ABS	1
4016.2	Koku Tutucu	ABS	1
4016.3	Paslanmaz Izgara	AISI 304	1
4016.4	Height Ayarlı Montaj Seti	PP	2

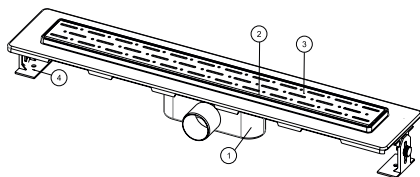

Code	W	L	H	Ø D	A	B	C	X	E	B1	A1
4016.0Y050K.033.1	423	134	72	49.5	360	88.9	11.35	385	1	56	325
4016.0Y050K.040.1	492	134	72	49.5	430	88.9	11.35	456	1	56	395
4016.0Y050K.050.1	592	134	72	49.5	530	88.9	11.35	556	1.5	56	495
4016.0Y050K.060.1	693	134	72	49.5	630	88.9	11.35	656	1.5	56	595
4016.0Y050K.080.1	893	134	72	49.5	830	88.9	11.35	856	1.5	56	795

Code	W	L	H	Ø D	A	B	C	X	E	B1	A1
4016.0A050K.033.1	423	134	100	49.5	360	88.9	11.35	385	1	56	325
4016.0A050K.040.1	492	134	100	49.5	430	88.9	11.35	456	1	56	395
4016.0A050K.050.1	592	134	100	49.5	530	88.9	11.35	556	1.5	56	495
4016.0A050K.060.1	693	134	100	49.5	630	88.9	11.35	656	1.5	56	595
4016.0A050K.080.1	893	134	100	49.5	830	88.9	11.35	856	1.5	56	795

Table measure "mm"

Details

DN 50 side and vertical outlet - compatible with PVC pipe connections, blocking odor by water (36mm). The flow rate is 32 liters/min. Resistant against external chemical effects, operating temperature is between -30°C and +75°C. The grid is made of 304 grade stainless steel.

Advantages

With its 304 grade stainless steel grid, it has a quality and stylish-looking. It can be easily applied at floor. With its odor blocking by water support, it prevents the bad smell coming from the installation. With its adjustable height legs, it can be adjusted depending on the screed concrete. High resistance against the organic and inorganic chemicals, resistant against most acidic and vertically aqueous oxidation.

Areas of Usage

Common use of bathroom shower, hospital and hotel shower areas, locker-room shower areas etc.

Customized Production

Grid patterns can be chosen in gold, bronze or other optional colors in accordance with your desire.

Warning

It is not recommended to use high-density cleaners for a long time.

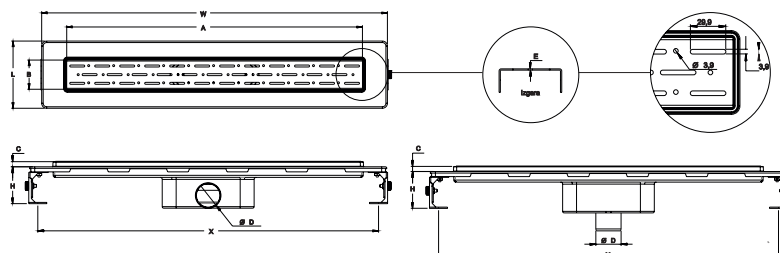

Code

Smart Code

Outlet

Size



Price \$

LINE

4023.0Y050K.033.1	16648	Ø 50	33 cm	12	16.00
4023.0Y050K.040.1	16669	Ø 50	40 cm	12	17.67
4023.0Y050K.050.1	16689	Ø 50	50 cm	12	20.33
4023.0Y050K.060.1	16705	Ø 50	60 cm	12	24.34
4023.0Y050K.080.1	18687	Ø 50	80 cm	12	28.68

* Shower drain / Ø 50 horizontal outlet / Plastic body / Stainless grid / Odor blocking by water
 * Душевой канал / Ø 50 Боковой выход / пластичное тело / Нержавеющая решетка / Гидрозатвор
 قنارة دش / Ø 50 / مصرف جانبي / جسم بلاستيكي / شبكة مقاومة للصدأ / حابس رائحة مياه



4023.0A050K.033.1	16723	Ø 50	33 cm	12	16.00
4023.0A050K.040.1	16742	Ø 50	40 cm	12	17.67
4023.0A050K.050.1	16755	Ø 50	50 cm	12	20.33
4023.0A050K.060.1	16769	Ø 50	60 cm	12	24.34
4023.0A050K.080.1	18720	Ø 50	80 cm	12	28.68

* Shower drain / Ø 50 vertical outlet / Plastic body / Stainless grid / Odor blocking by water
 * Душевой канал / Ø 50 Нижний выход / пластичное тело / Нержавеющая решетка / Гидрозатвор
 قنارة دش / Ø 50 / بمصرف سفلي / جسم بلاستيكي / شبكة مقاومة للصدأ / حابس رائحة مياه

Code

Smart Code

Outlet

Size



Price \$

LINE T.M.

4023.TY050K.033.1	16739	Ø 50	33 cm	12	20.00
4023.TY050K.040.1	16768	Ø 50	40 cm	12	22.33
4023.TY050K.050.1	16783	Ø 50	50 cm	12	25.67
4023.TY050K.060.1	16800	Ø 50	60 cm	12	30.67
4023.TY050K.080.1	18739	Ø 50	80 cm	12	35.33

* Shower drain / Ø 50 side outlet / Plastic body / Stainless grid / Textile membrane / Odor blocking by water
 * Душевой канал / Ø 50 боковой выход / пластичное тело / Нержавеющая решетка / Текстиль Мембраны / Гидрозатвор
 قنارة دش / مصرف جانبي / هيكل بلاستيكي / نسيج شبكة مقاومة للصدأ / حابس رائحة المياه



4023.TA050K.033.1	16791	Ø 50	33 cm	12	20.00
4023.TA050K.040.1	16805	Ø 50	40 cm	12	22.33
4023.TA050K.050.1	16818	Ø 50	50 cm	12	25.67
4023.TA050K.060.1	16832	Ø 50	60 cm	12	30.67
4023.TA050K.080.1	18763	Ø 50	80 cm	12	35.33

* Shower drain / Ø 50 vertical outlet / Plastic body / Stainless grid / Textile membrane / Odor blocking by water
 * Душевой канал / Ø 50 Нижний выход / пластичное тело / Нержавеющая решетка / Текстиль Мембраны / Гидрозатвор
 قنارة دش / بمصرف سفلي / هيكل بلاستيكي / نسيج شبكة مقاومة للصدأ / حابس رائحة المياه



Code Smart Code Outlet Size Price \$ LEGAL

4024.0Y050K.033.1	16842	Ø 50	33 cm	12	20.33
4024.0Y050K.040.1	16857	Ø 50	40 cm	12	22.34
4024.0Y050K.050.1	16880	Ø 50	50 cm	12	25.67
4024.0Y050K.060.1	16902	Ø 50	60 cm	12	28.33
4024.0Y050K.080.1	18723	Ø 50	80 cm	12	35.00

* Shower drain / Ø 50 vertical outlet / Stainless body / Stainless grid / Odor blocking by water
 * Душевой канал / Ø 50 Нижний выход / Нержавеющее тело / Нержавеющая решетка / Гидрозатвор / قنارة دش / ٥٠٠ بمصرف جانبي / شبكة بلاستيكي / شبكة مقاومة للصدأ / حابس رائحة المياه

4024.0A050K.033.1	16841	Ø 50	33 cm	12	20.33
4024.0A050K.040.1	16860	Ø 50	40 cm	12	22.34
4024.0A050K.050.1	16876	Ø 50	50 cm	12	25.67
4024.0A050K.060.1	16892	Ø 50	60 cm	12	28.33
4024.0A050K.080.1	18740	Ø 50	80 cm	12	35.00

* Shower drain / Ø 50 horizontal outlet / Stainless body / Stainless grid / Odor blocking by water
 * Душевой канал / Ø 50 Боковой выход / Нержавеющее тело / Нержавеющая решетка / Гидрозатвор / قنارة دش / ٥٠٠ بمصرف سفلي / شبكة بلاستيكي / شبكة مقاومة للصدأ / حابس رائحة المياه



Code Smart Code Outlet Size Price \$ LEGAL T.M.

4024.TY050K.033.1	16922	Ø 50	33 cm	12	24.67
4024.TY050K.040.1	16940	Ø 50	40 cm	12	27.67
4024.TY050K.050.1	16951	Ø 50	50 cm	12	31.00
4024.TY050K.060.1	16968	Ø 50	60 cm	12	34.67
4024.TY050K.080.1	18754	Ø 50	80 cm	12	40.67

* Shower drain / Ø 50 side outlet / Plastic body / Stainless grid Stainless frame / Textile membrane / Odor blocking by water
 * Душевой канал / Ø 50 боковой выход / пластиковое тело / Нержавеющая решетка / Текстиль Мембраны / Гидрозатвор / قنارة دش / مصرف جانبي / هيكل بلاستيكي / شبكة نسيجي وإطار مقاوم للصدأ / حابس رائحة المياه

4024.TA050K.033.1	16915	Ø 50	33 cm	12	24.67
4024.TA050K.040.1	16941	Ø 50	40 cm	12	27.67
4024.TA050K.050.1	16967	Ø 50	50 cm	12	31.00
4024.TA050K.060.1	16986	Ø 50	60 cm	12	34.67
4024.TA050K.080.1	18770	Ø 50	80 cm	12	40.67

* Shower drain / Ø 50 vertical outlet / Plastic body / Odor blocking by water Stainless frame / Textile membrane / Odor blocking by water
 * Душевой канал / Ø 50 Нижний выход / пластиковое тело / Нержавеющая решетка / Текстиль Мембраны / Гидрозатвор / قنارة دش / بمصرف سفلي / هيكل بلاستيكي / شبكة نسيجي وإطار مقاوم للصدأ / حابس رائحة المياه

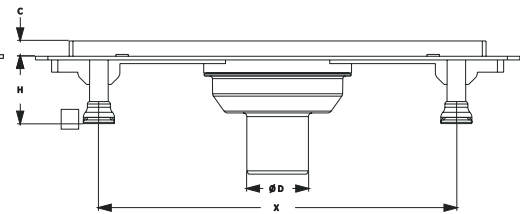
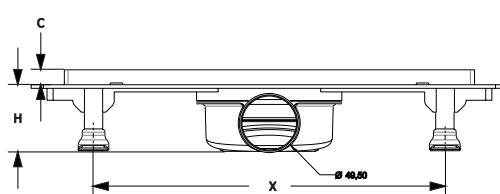
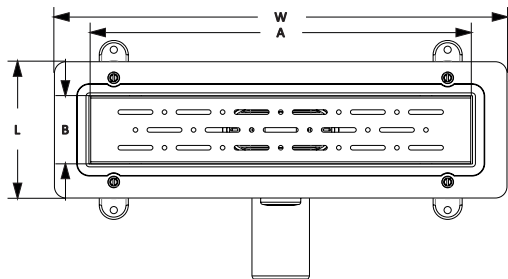
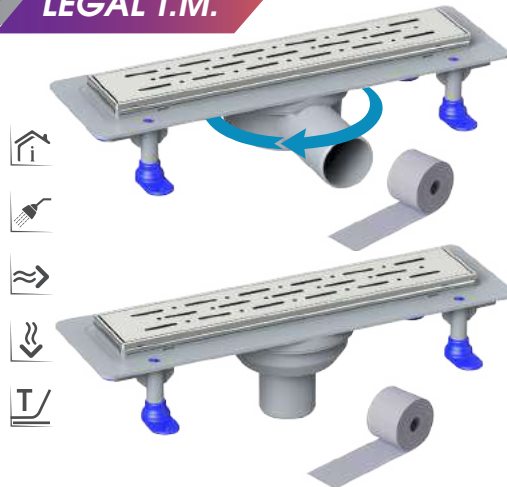

	W	L	H	Ø D	A	B	C	X	E
4024.0Y050K.033.1	389	119	55	50	335	64.5	12.5	287	1.2
4024.0Y050K.040.1	454	119	55	50	405	64.5	12.5	387	1.2
4024.0Y050K.050.1	554	119	55	50	505	64.5	12.5	487	1.2
4024.0Y050K.060.1	654	119	55	50	605	64.5	12.5	587	1.2

	W	L	H	Ø D	A	B	C	X	E
4024.0A050K.033.1	389	119	55	50	335	64.5	12.5	287	1.2
4024.0A050K.040.1	454	119	55	50	405	64.5	12.5	387	1.2
4024.0A050K.050.1	554	119	55	50	505	64.5	12.5	487	1.2
4024.0A050K.060.1	654	119	55	50	605	64.5	12.5	587	1.2

Table measure "mm"



Code Smart Code Outlet Size Price \$ DELUXE

4025.0Y050K.033.1	16978	Ø 50	33 cm	12	25.46
4025.0Y050K.040.1	17003	Ø 50	40 cm	12	27.49
4025.0Y050K.050.1	17031	Ø 50	50 cm	12	31.56
4025.0Y050K.060.1	17041	Ø 50	60 cm	12	35.64
4025.0Y050K.080.1	18784	Ø 50	80 cm	12	42.65

* Shower drain / Ø 50 vertical outlet / Stainless body / Stainless grid / Odor blocking by water
 * Душевой канал / Ø 50 Нижний выход / Нержавеющее тело / Нержавеющая решетка / Гидрозатвор
 قنّاة دش / هيكل بلاستيكي / مع مخرج ٥٠ ملم / و شبكة مقاومه للصدأ / مع مانع الروائح الكريهة



4025.0A050K.033.1	17004	Ø 50	33 cm	12	25.46
4025.0A050K.040.1	17018	Ø 50	40 cm	12	27.49
4025.0A050K.050.1	17030	Ø 50	50 cm	12	31.56
4025.0A050K.060.1	17071	Ø 50	60 cm	12	35.64
4025.0A050K.080.1	18795	Ø 50	80 cm	12	42.65

* Shower drain / Ø 50 horizontal outlet / Stainless body / Stainless grid / Odor blocking by water
 * Душевой канал / Ø 50 Боковой выход / Нержавеющее тело / Нержавеющая решетка / Гидрозатвор
 قنّاة دش / هيكل بلاستيكي / مع مخرج ٥٠ ملم / و شبكة مقاومه للصدأ / مع مانع الروائح الكريهة

Code Smart Code Outlet Size Price \$ DELUXE T.M.

4025.TY050K.033.1	17050	Ø 50	33 cm	12	28.33
4025.TY050K.040.1	17059	Ø 50	40 cm	12	31.33
4025.TY050K.050.1	17081	Ø 50	50 cm	12	35.66
4025.TY050K.060.1	17098	Ø 50	60 cm	12	40.33
4025.TY050K.080.1	18792	Ø 50	80 cm	12	47.33

* Shower drain / Ø 50 side outlet / Plastic body / Stainless grid Stainless frame / Textile membrane / Odor blocking by water
 * Душевой канал / Ø 50 боковой выход / пластичное тело / Нержавеющая решетка / Текстиль Мембраны / Гидрозатвор
 قنّاة دش / هيكل بلاستيكي / مع مخرج ٥٠ ملم / و شبكة مقاومه للصدأ / مع مانع الروائح الكريهة

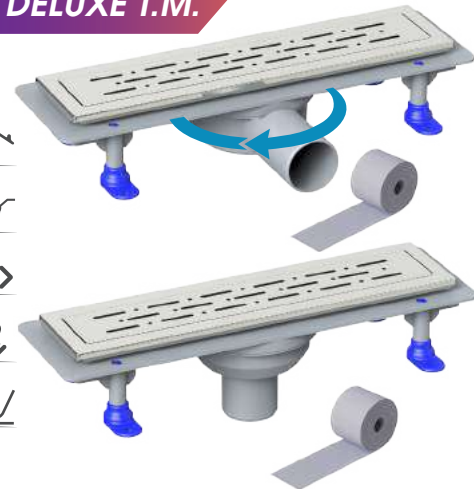

4025.TA050K.033.1	17085	Ø 50	33 cm	12	28.33
4025.TA050K.040.1	17130	Ø 50	40 cm	12	31.33
4025.TA050K.050.1	17145	Ø 50	50 cm	12	35.66
4025.TA050K.060.1	17160	Ø 50	60 cm	12	40.33
4025.TA050K.080.1	18815	Ø 50	80 cm	12	47.33

* Shower drain / Ø 50 vertical outlet / Plastic body / Odor blocking by water Stainless frame / Textile membrane / Odor blocking by water
 * Душевой канал / Ø 50 Нижний выход / пластичное тело / Нержавеющая решетка / Текстиль Мембраны / Гидрозатвор
 قنّاة دش / هيكل بلاستيكي / مع مخرج ٥٠ ملم / و شبكة مقاومه للصدأ / مع مانع الروائح الكريهة



SCALA

Code	Smart Code	Outlet	Size		Price \$
4026.0Y050K.033.1	17107	Ø 50	33 cm	12	16.00
4026.0Y050K.040.1	17108	Ø 50	40 cm	12	18.00
4026.0Y050K.050.1	17109	Ø 50	50 cm	12	20.33
4026.0Y050K.060.1	17110	Ø 50	60 cm	12	22.34
4026.0Y050K.080.1	18806	Ø 50	80 cm	12	29.00

* Shower drain / Ø 50 horizontal outlet / Plastic body / Stainless grid / Odor blocking by water
 * Душевой канал / Ø 50 Боковой выход / пластичное тело / Нержавеющая решетка / Гидрозатвор / قنارة دش / هيكل مقاوم للصدأ / مع مخرج ٥٠ ملم / و شبكة مقاومه للصدأ / مع مانع الروائح الكريهة

Code	Smart Code	Outlet	Size		Price \$
4026.0A050K.033.1	17111	Ø 50	33 cm	12	16.00
4026.0A050K.040.1	17112	Ø 50	40 cm	12	18.00
4026.0A050K.050.1	17113	Ø 50	50 cm	12	20.33
4026.0A050K.060.1	17114	Ø 50	60 cm	12	22.34
4026.0A050K.080.1	18810	Ø 50	80 cm	12	29.00

* Shower drain / Ø 50 vertical outlet / Plastic body / Stainless grid / Odor blocking by water
 * Душевой канал / Ø 50 Нижний выход / пластичное тело / Нержавеющая решетка / Гидрозатвор / قنارة دش / هيكل مقاوم للصدأ / مع مخرج ٥٠ ملم / و غطاء مقاوم للصدأ من اجل السيراميك / مع مانع الروائح الكريهة

SCALA T.M.

Code	Smart Code	Outlet	Size		Price \$
4026.TY050K.033.1	17115	Ø 50	33 cm	12	19.33
4026.TY050K.040.1	17116	Ø 50	40 cm	12	21.67
4026.TY050K.050.1	17117	Ø 50	50 cm	12	25.00
4026.TY050K.060.1	17118	Ø 50	60 cm	12	27.67
4026.TY050K.080.1	18813	Ø 50	80 cm	12	34.67

* Shower drain / Ø 50 side outlet / Plastic body / Stainless grid Textile membrane / Odor blocking by water
 * Душевой канал / Ø 50 боковой выход / пластичное тело / Нержавеющая решетка / Текстиль Мембраны / Гидрозатвор / قنارة دش / هيكل مقاوم للصدأ / مع مخرج ٥٠ ملم / و غطاء مقاوم للصدأ من اجل السيراميك / مع مانع الروائح الكريهة

Code	Smart Code	Outlet	Size		Price \$
4026.TA050K.033.1	17119	Ø 50	33 cm	12	19.33
4026.TA050K.040.1	17120	Ø 50	40 cm	12	21.67
4026.TA050K.050.1	17121	Ø 50	50 cm	12	25.00
4026.TA050K.060.1	17122	Ø 50	60 cm	12	27.67
4026.TA050K.080.1	18816	Ø 50	80 cm	12	34.67

* Shower drain / Ø 50 vertical outlet / Plastic body / Stainless grid Textile membrane / Odor blocking by water
 * Душевой канал / Ø 50 Нижний выход / пластичное тело / Нержавеющая решетка / Текстиль Мембраны / Гидрозатвор / قنارة دش / هيكل مقاوم للصدأ / مع مخرج ٥٠ ملم / و غطاء مقاوم للصدأ من اجل السيراميك / مع مانع الروائح الكريهة

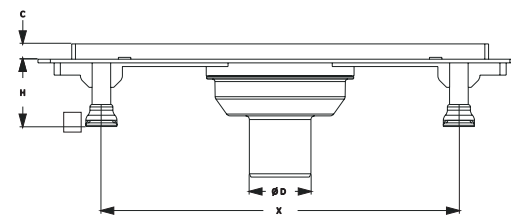
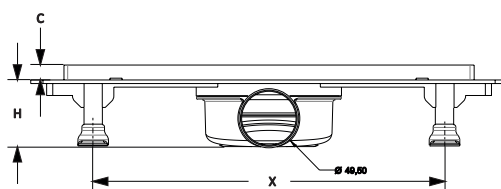
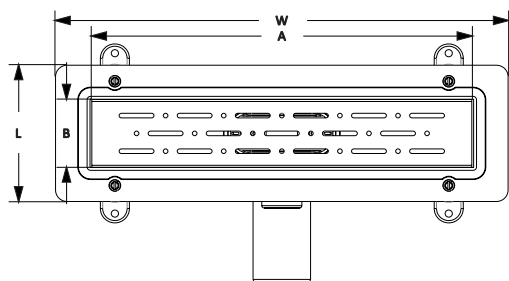

	W	L	H	Ø D	A	B	C	X	E
4024.0Y050K.033.1	389	119	55	50	335	64.5	12.5	287	1.2
4024.0Y050K.040.1	454	119	55	50	405	64.5	12.5	387	1.2
4024.0Y050K.050.1	554	119	55	50	505	64.5	12.5	487	1.2
4024.0Y050K.060.1	654	119	55	50	605	64.5	12.5	587	1.2

	W	L	H	Ø D	A	B	C	X	E
4024.0A050K.033.1	389	119	55	50	335	64.5	12.5	287	1.2
4024.0A050K.040.1	454	119	55	50	405	64.5	12.5	387	1.2
4024.0A050K.050.1	554	119	55	50	505	64.5	12.5	487	1.2
4024.0A050K.060.1	654	119	55	50	605	64.5	12.5	587	1.2

Table measure "mm"



Code

Smart Code

Outlet

Size



Price \$

SCALA LEGAL

4027.0Y050K.033.1	17128	Ø 50	33 cm	12	21.33
4027.0Y050K.040.1	17131	Ø 50	40 cm	12	23.00
4027.0Y050K.050.1	17133	Ø 50	50 cm	12	25.67
4027.0Y050K.060.1	17135	Ø 50	60 cm	12	28.00
4027.0Y050K.080.1	18818	Ø 50	80 cm	12	34.67

* Shower drain / Ø 50 vertical outlet / Stainless body / Stainless grid / Odor blocking by water
 * Душевой канал / Ø 50 Нижний выход / Нержавеющее тело / Нержавеющая решетка / Гидрозатвор
 قنّاة دش / هيكل مقاوم للصدأ / مع مخرج ٥٠ ملم / و غطاء مقاوم للصدأ من اجل السيراميك / مع مانع الروائح الكريهه



4027.0A050K.033.1	17138	Ø 50	33 cm	12	21.33
4027.0A050K.040.1	17141	Ø 50	40 cm	12	23.00
4027.0A050K.050.1	17143	Ø 50	50 cm	12	25.67
4027.0A050K.060.1	17146	Ø 50	60 cm	12	28.00
4027.0A050K.080.1	18822	Ø 50	80 cm	12	34.67

* Shower drain / Ø 50 horizontal outlet / Stainless body / Stainless grid / Odor blocking by water
 * Душевой канал / Ø 50 Боковой выход / Нержавеющее тело / Нержавеющая решетка / Гидрозатвор
 قنّاة دش / هيكل مقاوم للصدأ / مع مخرج ٥٠ ملم / و غطاء مقاوم للصدأ من اجل السيراميك / مع مانع الروائح الكريهه

Code

Smart Code

Outlet

Size



Price \$

SCALA LEGAL T.M.

4027.TY050K.033.1	17148	Ø 50	33 cm	12	23.00
4027.TY050K.040.1	17151	Ø 50	40 cm	12	25.67
4027.TY050K.050.1	17153	Ø 50	50 cm	12	29.00
4027.TY050K.060.1	17156	Ø 50	60 cm	12	31.67
4027.TY050K.080.1	18824	Ø 50	80 cm	12	39.00

* Shower drain / Ø 50 side outlet / Plastic body / Stainless grid Stainless frame / Textile membrane / Odor blocking by water
 * Душевой канал / Ø 50 боковой выход / пластиковое тело / Нержавеющая решетка / Текстиль Мембраны / Гидрозатвор
 قنّاة دش / هيكل مقاوم للصدأ / مع مخرج ٥٠ ملم / و غطاء مقاوم للصدأ من اجل السيراميك / مع مانع الروائح الكريهه



4027.TA050K.033.1	17159	Ø 50	33 cm	12	23.00
4027.TA050K.040.1	17161	Ø 50	40 cm	12	25.67
4027.TA050K.050.1	17163	Ø 50	50 cm	12	29.00
4027.TA050K.060.1	17165	Ø 50	60 cm	12	31.67
4027.TA050K.080.1	18828	Ø 50	80 cm	12	39.00

* Shower drain / Ø 50 vertical outlet / Plastic body / Odor blocking by water Stainless frame / Textile membrane / Odor blocking by water
 * Душевой канал / Ø 50 Нижний выход / пластиковое тело / Нержавеющая решетка / Текстиль Мембраны / Гидрозатвор
 قنّاة دش / هيكل مقاوم للصدأ / مع مخرج ٥٠ ملم / و غطاء مقاوم للصدأ من اجل السيراميك / مع مانع الروائح الكريهه

SHOWER DRAINS

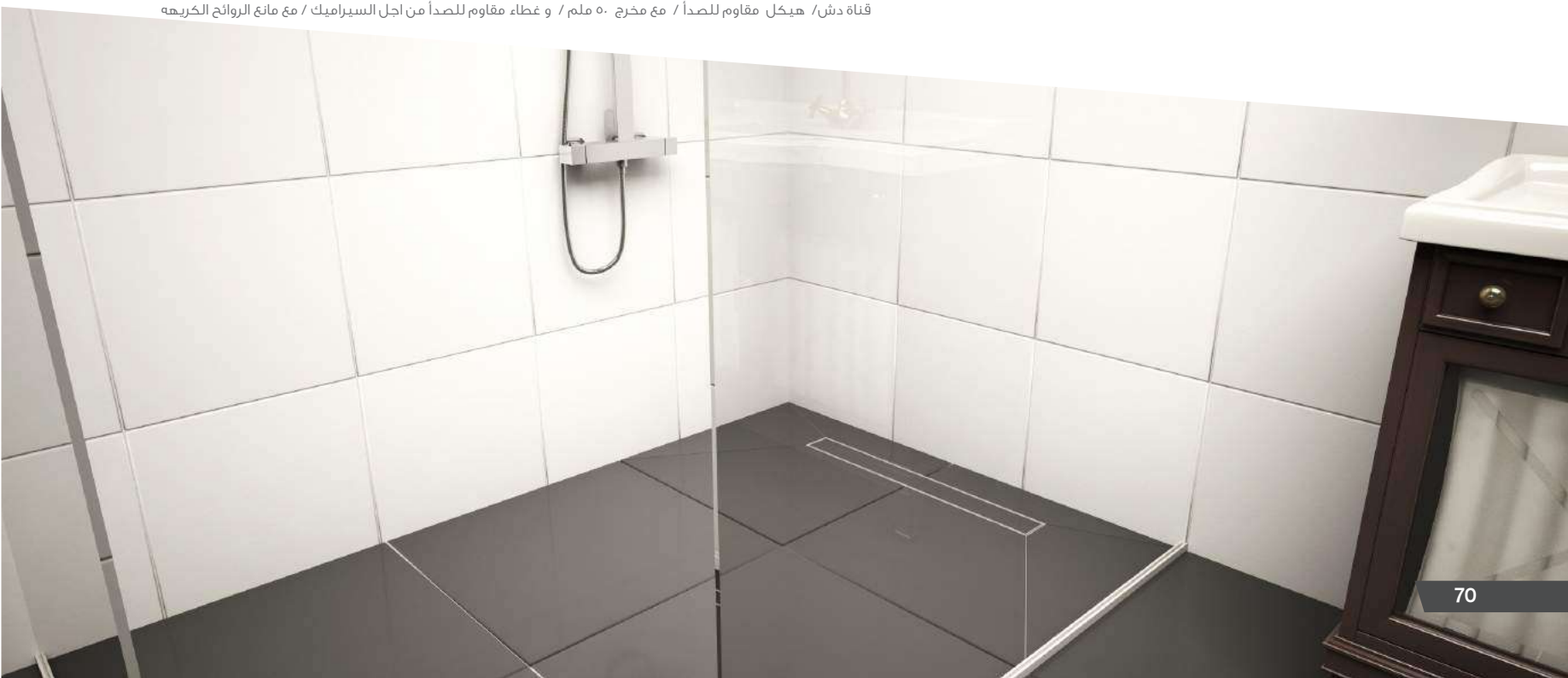

SCALA DELUXE

Code	Smart Code	Outlet	Size		Price \$
4028.0Y050K.033.1	17173	Ø 50	33 cm	12	25.00
4028.0Y050K.040.1	17176	Ø 50	40 cm	12	27.00
4028.0Y050K.050.1	17177	Ø 50	50 cm	12	31.00
4028.0Y050K.060.1	17178	Ø 50	60 cm	12	34.67
4028.0Y050K.080.1	18830	Ø 50	80 cm	12	42.67

* Shower drain / Ø 50 vertical outlet / Stainless body / Stainless grid / Odor blocking by water
 * Душевой канал / Ø 50 Нижний выход / Нержавеющее тело / Нержавеющая решетка / Гидрозатвор
 قنطرة دش / هيكل مقاوم للصدأ / مع مخرج ٥٠ ملم / و غطاء مقاوم للصدأ من اجل السيراميك / مع مانع الروائح الكريهة

Code	Smart Code	Outlet	Size		Price \$
4028.0A050K.033.1	17167	Ø 50	33 cm	12	25.00
4028.0A050K.040.1	17174	Ø 50	40 cm	12	27.00
4028.0A050K.050.1	17175	Ø 50	50 cm	12	31.00
4028.0A050K.060.1	17179	Ø 50	60 cm	12	34.67
4028.0A050K.080.1	18831	Ø 50	80 cm	12	42.67

* Shower drain / Ø 50 horizontal outlet / Stainless body / Stainless grid / Odor blocking by water
 * Душевой канал / Ø 50 Боковой выход / Нержавеющее тело / Нержавеющая решетка / Гидрозатвор
 قنطرة دش / هيكل مقاوم للصدأ / مع مخرج ٥٠ ملم / و غطاء مقاوم للصدأ من اجل السيراميك / مع مانع الروائح الكريهة



SCALA DELUXE T.M.

Code	Smart Code	Outlet	Size		Price \$
4028.TY050K.033.1	17181	Ø 50	33 cm	12	27.67
4028.TY050K.040.1	17182	Ø 50	40 cm	12	30.00
4028.TY050K.050.1	17183	Ø 50	50 cm	12	34.67
4028.TY050K.060.1	17184	Ø 50	60 cm	12	38.33
4028.TY050K.080.1	18832	Ø 50	80 cm	12	48.00

* Shower drain / Ø 50 side outlet / Plastic body / Stainless grid Stainless frame / Textile membrane / Odor blocking by water
 * Душевой канал / Ø 50 боковой выход / пластичное тело / Нержавеющая решетка / Текстиль Мембраны / Гидрозатвор

قنطرة دش / هيكل مقاوم للصدأ / مع مخرج ٥٠ ملم / و غطاء مقاوم للصدأ من اجل السيراميك / مع مانع الروائح الكريهة

Code	Smart Code	Outlet	Size		Price \$
4028.TA050K.033.1	17180	Ø 50	33 cm	12	27.67
4028.TA050K.040.1	17185	Ø 50	40 cm	12	30.00
4028.TA050K.050.1	17187	Ø 50	50 cm	12	34.67
4028.TA050K.060.1	17188	Ø 50	60 cm	12	38.33
4028.TA050K.080.1	18833	Ø 50	80 cm	12	48.00

* Shower drain / Ø 50 vertical outlet / Plastic body / Odor blocking by water Stainless frame / Textile membrane / Odor blocking by water

* Душевой канал / Ø 50 Нижний выход / пластичное тело / Нержавеющая решетка / Текстиль Мембраны / Гидрозатвор

قنطرة دش / هيكل مقاوم للصدأ / مع مخرج ٥٠ ملم / و غطاء مقاوم للصدأ من اجل السيراميك / مع مانع الروائح الكريهة

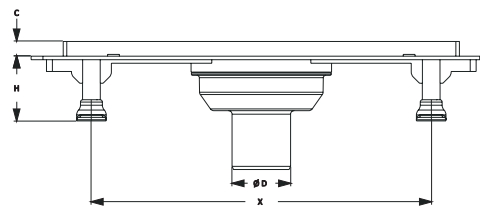
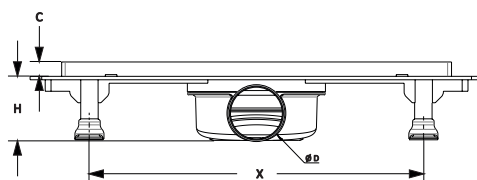
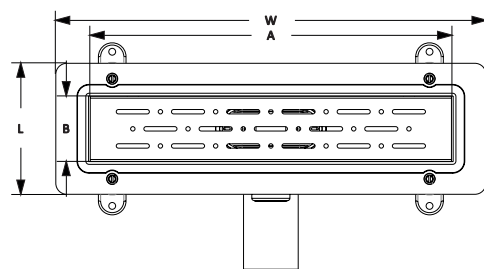

Details

DN 50 side and vertical outlet - compatible with PVC pipe connections, blocking odor by water (36mm). The flow rate is 32 liters/min. Resistant against external chemical effects, operating temperature is between -30°C and +75°C. The grid is made of 304 grade stainless steel.

Advantages

With its 304 grade stainless steel grid, it has a quality and stylish-looking. It can be easily applied at floor. With its odor blocking by water support, it prevents the bad smell coming from the installation. With its adjustable height legs, it can be adjusted depending on the screed concrete. High resistance against the organic and inorganic chemicals, resistant against most acidic and vertically aqueous oxidation.

Areas of Usage

Common use of bathroom shower, hospital and hotel shower areas, locker-room shower areas etc.

Customized Production

Grid patterns can be chosen in gold, bronze or other optional colors in accordance with your desire.

Warning

It is not recommended to use high-density cleaners for a long time.

	W	L	H	ØD	A	B	C	X	E
4028.0Y050K.033.1	389	119	55	50	335	64.5	12.5	287	1.2
4028.0Y050K.040.1	454	119	55	50	405	64.5	12.5	387	1.2
4028.0Y050K.050.1	554	119	55	50	505	64.5	12.5	487	1.2
4028.0Y050K.060.1	654	119	55	50	605	64.5	12.5	587	1.2

	W	L	H	ØD	A	B	C	X	E
4028.0A050K.033.1	389	119	55	50	335	64.5	12.5	287	1.2
4028.0A050K.040.1	454	119	55	50	405	64.5	12.5	387	1.2
4028.0A050K.050.1	554	119	55	50	505	64.5	12.5	487	1.2
4028.0A050K.060.1	654	119	55	50	605	64.5	12.5	587	1.2

Table measure "mm"

Code	Smart Code	Outlet	Size		Price \$	LINE
------	------------	--------	------	---	----------	------

4033.0Y050K.033.1	17186	Ø 50	33 cm	12	25.67	
4033.0Y050K.040.1	17203	Ø 50	40 cm	12	28.00	
4033.0Y050K.050.1	17216	Ø 50	50 cm	12	32.67	
4033.0Y050K.060.1	17236	Ø 50	60 cm	12	36.67	
4033.0Y050K.080.1	17249	Ø 50	80 cm	12	44.33	

* Shower drain / Ø 50 vertical outlet / Stainless body / Stainless grid / Odor blocking by water
 * Душевой канал / Ø 50 Нижний выход / Нержавеющее тело / Нержавеющая решетка / Гидрозатвор
 قناة دش / هيكل بلاستيكي / مع مخرج ٥٠ ملم / و شبكة مقاومه للصدأ / مع مانع الروائح الكريهة



4033.0A050K.033.1	17189	Ø 50	33 cm	12	25.67	
4033.0A050K.040.1	17214	Ø 50	40 cm	12	28.00	
4033.0A050K.050.1	17233	Ø 50	50 cm	12	32.67	
4033.0A050K.060.1	17261	Ø 50	60 cm	12	36.67	
4033.0A050K.080.1	17282	Ø 50	80 cm	12	44.33	

* Shower drain / Ø 50 horizontal outlet / Stainless body / Stainless grid / Odor blocking by water
 * Душевой канал / Ø 50 Боковой выход / Нержавеющее тело / Нержавеющая решетка / Гидрозатвор
 قناة دش / هيكل بلاستيكي / مع مخرج ٥٠ ملم / و شبكة مقاومه للصدأ / مع مانع الروائح الكريهة

Code	Smart Code	Outlet	Size		Price \$	LINE GOLD
------	------------	--------	------	---	----------	-----------

4033.0Y050G.033.1	17258	Ø 50	33 cm	12	37.33	
4033.0Y050G.040.1	17278	Ø 50	40 cm	12	41.67	
4033.0Y050G.050.1	17297	Ø 50	50 cm	12	49.00	
4033.0Y050G.060.1	17314	Ø 50	60 cm	12	58.33	
4033.0Y050G.080.1	17333	Ø 50	80 cm	12	69.00	

* Shower drain / Ø 50 vertical outlet / Stainless body / Stainless grid / Odor blocking by water
 * Душевой канал / Ø 50 Нижний выход / Нержавеющее тело / Нержавеющая решетка / Гидрозатвор
 قناة دش / هيكل بلاستيكي / مع مخرج ٥٠ ملم / و شبكة مقاومه للصدأ / مع مانع الروائح الكريهة



4033.0A050G.033.1	17294	Ø 50	33 cm	12	37.33	
4033.0A050G.040.1	17315	Ø 50	40 cm	12	41.67	
4033.0A050G.050.1	17343	Ø 50	50 cm	12	49.00	
4033.0A050G.060.1	17354	Ø 50	60 cm	12	58.33	
4033.0A050G.080.1	17374	Ø 50	80 cm	12	69.00	

* Shower drain / Ø 50 horizontal outlet / Stainless body / Stainless grid / Odor blocking by water
 * Душевой канал / Ø 50 Боковой выход / Нержавеющее тело / Нержавеющая решетка / Гидрозатвор
 قناة دش / هيكل بلاستيكي / مع مخرج ٥٠ ملم / و شبكة مقاومه للصدأ / مع مانع الروائح الكريهة



Code Smart Code Outlet Size Price \$ LINE T.M.

4033.TY050K.033.1	17358	Ø 50	33 cm	12	26.67
4033.TY050K.040.1	17372	Ø 50	40 cm	12	29.33
4033.TY050K.050.1	17398	Ø 50	50 cm	12	34.00
4033.TY050K.060.1	17410	Ø 50	60 cm	12	38.00
4033.TY050K.080.1	17434	Ø 50	80 cm	12	46.00

* Shower drain / Ø 50 side outlet / Plastic body / Adjustable height stainless frame / Textile membrane / Odor blocking by water

* Душевой канал / Ø 50 боковой выход / пластичное тело / С регулировкой высоты / Нержавеющая решетка / Текстиль Мембраны / Гидрозатвор

قناة دش / هيكل بلاستيكي / مع مخرج ٥٠ ملم / و شبكة مقاومه للصدأ / مع مانع الروائح الكريهة

4033.TA050K.033.1	17385	Ø 50	33 cm	12	26.67
4033.TA050K.040.1	17411	Ø 50	40 cm	12	29.33
4033.TA050K.050.1	17426	Ø 50	50 cm	12	34.00
4033.TA050K.060.1	17444	Ø 50	60 cm	12	38.00
4033.TA050K.080.1	17467	Ø 50	80 cm	12	46.00

* Shower drain / Ø 50 vertical outlet / Plastic body / Adjustable height stainless frame / Textile membrane / Odor blocking by water

* Душ канал / Ø 50 Нижний выход / пластичное тело / С регулировкой высоты / Нержавеющая решетка / Текстиль Мембраны / Гидрозатвор

قناة دش / هيكل بلاستيكي / مع مخرج ٥٠ ملم / و شبكة مقاومه للصدأ / مع مانع الروائح الكريهة



Code Smart Code Outlet Size Price \$ LINE T.M.GOLD

4033.TY050G.033.1	17448	Ø 50	33 cm	12	43.67
4033.TY050G.040.1	17464	Ø 50	40 cm	12	48.67
4033.TY050G.050.1	17477	Ø 50	50 cm	12	57.33
4033.TY050G.060.1	17492	Ø 50	60 cm	12	62.33
4033.TY050G.080.1	17506	Ø 50	80 cm	12	73.33

* Shower drain / Ø 50 side outlet / Plastic body / Adjustable height stainless frame / Textile membrane / Odor blocking by water

* Душ канал / Ø 50 боковой выход / пластичное тело / С регулировкой высоты / Нержавеющая решетка / Текстиль Мембраны / Гидрозатвор

قناة دش / هيكل بلاستيكي / مع مخرج ٥٠ ملم / و شبكة مقاومه للصدأ / مع مانع الروائح الكريهة

4033.TA050G.033.1	17493	Ø 50	33 cm	12	43.67
4033.TA050G.040.1	17521	Ø 50	40 cm	12	48.67
4033.TA050G.050.1	17545	Ø 50	50 cm	12	57.33
4033.TA050G.060.1	17562	Ø 50	60 cm	12	62.33
4033.TA050G.080.1	17588	Ø 50	80 cm	12	73.33

* Shower drain / Ø 50 vertical outlet / Plastic body / Adjustable height stainless frame / Textile membrane / Odor blocking by water

* Душ канал / Ø 50 Нижний выход / пластичное тело / С регулировкой высоты / Нержавеющая решетка / Текстиль Мембраны / Гидрозатвор

قناة دش / هيكل بلاستيكي / مع مخرج ٥٠ ملم / و شبكة مقاومه للصدأ / مع مانع الروائح الكريهة

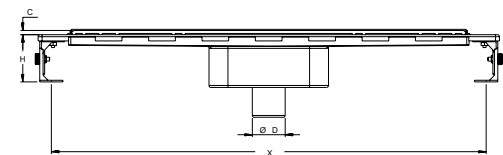
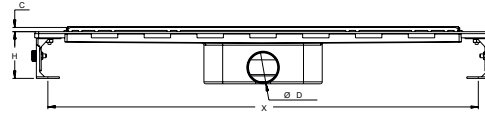
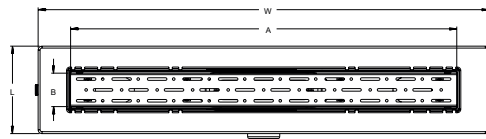
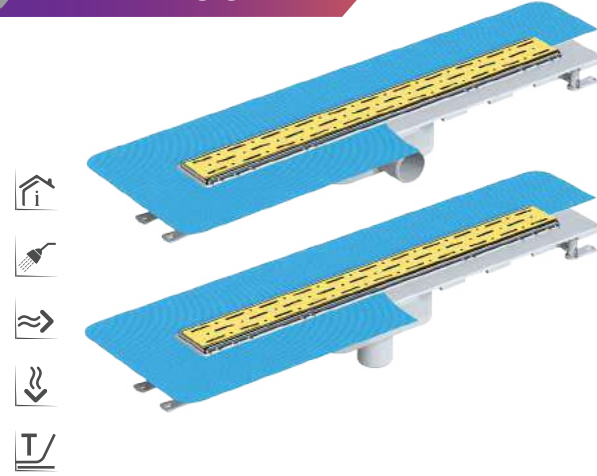

Code	W	L	H	Ø D	A	B	C	X	E
4033.TY050K.033.1	423	134	72	49.5	330	54	8	385	1.5
4033.TY050K.040.1	492	134	72	49.5	400	54	8	456	1.5
4033.TY050K.050.1	592	134	72	49.5	500	54	8	556	1.5
4033.TY050K.060.1	693	134	72	49.5	600	54	8	656	1.5
4033.TY050K.080.1	893	134	72	49.5	800	54	8	856	1.5

Code	W	L	H	Ø D	A	B	C	X	E
4033.TA050K.033.1	423	134	100	49.5	330	54	8	385	1.5
4033.TA050K.040.1	492	134	100	49.5	400	54	8	456	1.5
4033.TA050K.050.1	592	134	100	49.5	500	54	8	556	1.5
4033.TA050K.060.1	693	134	100	49.5	600	54	8	656	1.5
4033.TA050K.080.1	893	134	100	49.5	800	54	8	856	1.5

Table measure "mm"

PIECE OF	PARTS DESCRIPTION	MATERIAL	PIECE
4033.1	Plastik Gövde Etekli	ABS	1
4033.2	Height Ayarlı Montaj Seti	PP	2
4033.3	Koku Tutucu	ABS	1
4033.4	Yük. Ayarlı Çerçeve	AISI 304	1
4033.5	Paslanmaz Izgara	AISI 304	1

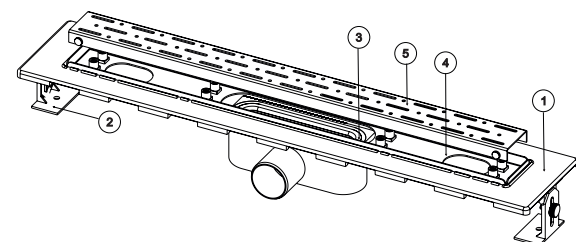

Code Smart Code Outlet Size Price \$ LEGAL

Code	Smart Code	Outlet	Size		Price \$
4043.0Y050K.033.1	17524	Ø 50	33 cm	12	46.67
4043.0Y050K.040.1	17538	Ø 50	40 cm	12	51.67
4043.0Y050K.050.1	17557	Ø 50	50 cm	12	58.33
4043.0Y050K.060.1	17575	Ø 50	60 cm	12	66.33
4043.0Y050K.080.1	18834	Ø 50	80 cm	12	76.33

* Shower drain / Ø 50 side outlet / Stainless body / Adjustable height stainless frame / Odor blocking by water
 * Душевой канал / Ø 50 боковой выход / Корпус Из Нержавеющей С регулировкой высоты / Нержавеющая решетка / Гидрозатвор
 قنارة دش / هيكل مقاوم للصدأ / مع مخرج ٥٠ ملم / و شبكة مقاومه للصدأ / مع مانع الروائح الكريهة

Code	Smart Code	Outlet	Size		Price \$
4043.0A050K.033.1	17601	Ø 50	33 cm	12	46.67
4043.0A050K.040.1	17619	Ø 50	40 cm	12	51.67
4043.0A050K.050.1	17640	Ø 50	50 cm	12	58.33
4043.0A050K.060.1	17661	Ø 50	60 cm	12	66.33
4043.0A050K.080.1	18994	Ø 50	80 cm	12	76.33

* Shower drain / Ø 50 vertical outlet / Stainless body Adjustable height stainless frame / Odor blocking by water
 * Душевой канал / Ø 50 Нижний выход / Корпус Из Нержавеющей С регулировкой высоты / Нержавеющая решетка / Гидрозатвор
 قنارة دش / هيكل مقاوم للصدأ / مع مخرج ٥٠ ملم / و شبكة مقاومه للصدأ / مع مانع الروائح الكريهة



Code Smart Code Outlet Size Price \$ LEGAL GOLD

Code	Smart Code	Outlet	Size		Price \$
4043.0Y050G.033.1	17604	Ø 50	33 cm	12	49.00
4043.0Y050G.040.1	17623	Ø 50	40 cm	12	54.67
4043.0Y050G.050.1	17639	Ø 50	50 cm	12	62.67
4043.0Y050G.060.1	17656	Ø 50	60 cm	12	70.00
4043.0Y050G.080.1	17673	Ø 50	80 cm	12	83.33

* Shower drain / Ø 50 side outlet / Stainless body / Adjustable height stainless frame / Odor blocking by water
 * Душевой канал / Ø 50 боковой выход / Корпус Из Нержавеющей С регулировкой высоты / Нержавеющая решетка / Гидрозатвор
 قنارة دش / هيكل مقاوم للصدأ / مع مخرج ٥٠ ملم / و شبكة مقاومه للصدأ / مع مانع الروائح الكريهة

Code	Smart Code	Outlet	Size		Price \$
4043.0A050G.033.1	17688	Ø 50	33 cm	12	49.00
4043.0A050G.040.1	17703	Ø 50	40 cm	12	54.67
4043.0A050G.050.1	17712	Ø 50	50 cm	12	62.67
4043.0A050G.060.1	17734	Ø 50	60 cm	12	70.00
4043.0A050G.080.1	17751	Ø 50	80 cm	12	83.33

* Shower drain / Ø 50 vertical outlet / Stainless body Adjustable height stainless frame / Odor blocking by water
 * Душевой канал / Ø 50 Нижний выход / Корпус Из Нержавеющей С регулировкой высоты / Нержавеющая решетка / Гидрозатвор
 قنارة دش / هيكل مقاوم للصدأ / مع مخرج ٥٠ ملم / و شبكة مقاومه للصدأ / مع مانع الروائح الكريهة

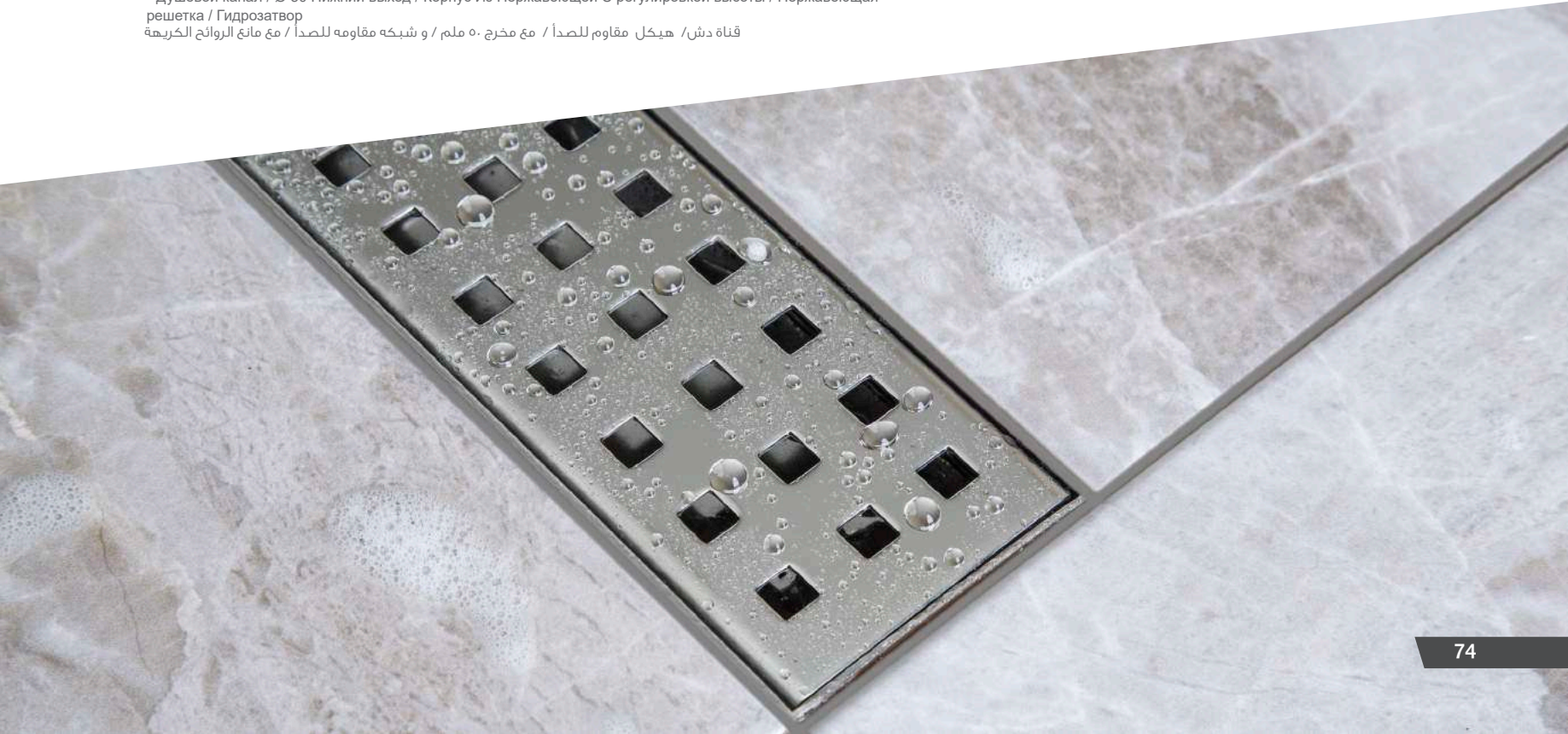

Code Smart Code Outlet Size Price \$ LEGAL T.M.

4043.TY050K.033.1	17717	Ø 50	33 cm	12	48.67
4043.TY050K.040.1	17732	Ø 50	40 cm	12	54.33
4043.TY050K.050.1	17750	Ø 50	50 cm	12	61.67
4043.TY050K.060.1	17767	Ø 50	60 cm	12	68.00
4043.TY050K.080.1	17783	Ø 50	80 cm	12	81.00

* Shower drain / Ø 50 side outlet / Stainless body / Adjustable height stainless frame / Textile membrane / Odor blocking by water

* Душевой канал / Ø 50 боковой выход / Корпус Из Нержавеющей / регулируемые по высоте сетки из нержавеющей стали / Текстиль Мембраны / Гидрозатвор

قناة دش / هيكل مقاوم للصدأ / مع مخرج ٥٠ ملم / و شبكة مقاومه للصدأ / مع مانع الروائح الكريهة



4043.TA050K.033.1	17771	Ø 50	33 cm	12	48.67
4043.TA050K.040.1	17789	Ø 50	40 cm	12	54.33
4043.TA050K.050.1	17801	Ø 50	50 cm	12	61.67
4043.TA050K.060.1	17810	Ø 50	60 cm	12	73.00
4043.TA050K.080.1	17823	Ø 50	80 cm	12	81.00

* Shower drain / Ø 50 vertical outlet / Stainless body / Adjustable height stainless frame / Textile membrane / Odor blocking by water

* Душевой канал / Ø 50 Нижний выход / Корпус Из Нержавеющей / регулируемые по высоте сетки из нержавеющей стали / Текстиль Мембраны / Гидрозатвор

قناة دش / هيكل مقاوم للصدأ / مع مخرج ٥٠ ملم / و شبكة مقاومه للصدأ / مع مانع الروائح الكريهة

Code Smart Code Outlet Size Price \$ LEGAL T.M.GOLD

4043.TY050G.033.1	17819	Ø 50	33 cm	12	52.00
4043.TY050G.040.1	17859	Ø 50	40 cm	12	58.34
4043.TY050G.050.1	17889	Ø 50	50 cm	12	66.67
4043.TY050G.060.1	17902	Ø 50	60 cm	12	73.33
4043.TY050G.080.1	17911	Ø 50	80 cm	12	88.67

* Shower drain / Ø 50 side outlet / Stainless body / Adjustable height stainless frame / Textile membrane / Odor blocking by water

* Душевой канал / Ø 50 боковой выход / Корпус Из Нержавеющей / регулируемые по высоте сетки из нержавеющей стали / Текстиль Мембраны / Гидрозатвор

قناة دش / هيكل مقاوم للصدأ / مع مخرج ٥٠ ملم / و شبكة مقاومه للصدأ / مع مانع الروائح الكريهة

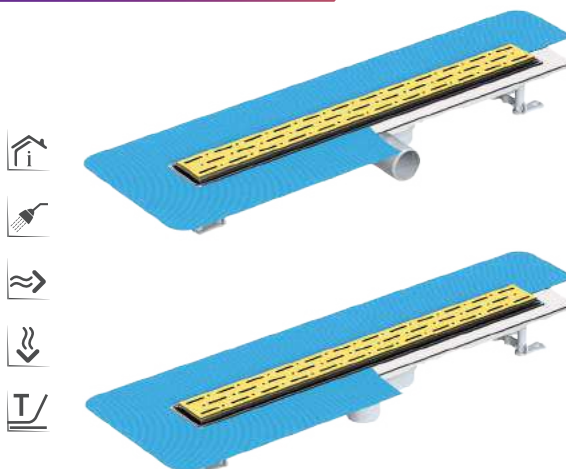

4043.TA050G.033.1	17832	Ø 50	33 cm	12	52.00
4043.TA050G.040.1	17845	Ø 50	40 cm	12	58.34
4043.TA050G.050.1	17856	Ø 50	50 cm	12	66.67
4043.TA050G.060.1	17868	Ø 50	60 cm	12	73.33
4043.TA050G.080.1	17880	Ø 50	80 cm	12	88.67

* Shower drain / Ø 50 vertical outlet / Stainless body / Adjustable height stainless frame / Textile membrane / Odor blocking by water

* Душевой канал / Ø 50 Нижний выход / Корпус Из Нержавеющей / регулируемые по высоте сетки из нержавеющей стали / Текстиль Мембраны / Гидрозатвор

قناة دش / هيكل مقاوم للصدأ / مع مخرج ٥٠ ملم / و شبكة مقاومه للصدأ / مع مانع الروائح الكريهة

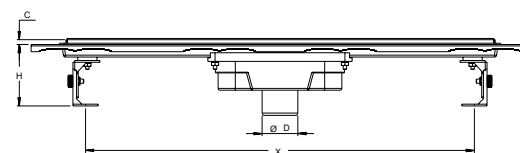
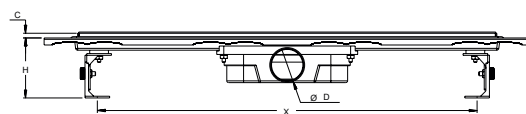
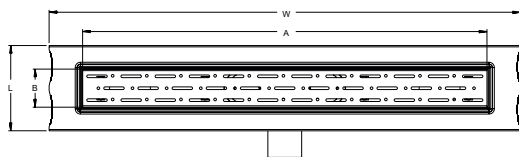

Code	W	L	H	Ø D	A	B	C	X	E
4043.TY050K.033.1	423	134	85	49.5	330	54	8	385	1.5
4043.TY050K.040.1	492	134	85	49.5	400	54	8	456	1.5
4043.TY050K.050.1	592	134	85	49.5	500	54	8	556	1.5
4043.TY050K.060.1	693	134	85	49.5	600	54	8	656	1.5
4043.TY050K.080.1	893	134	85	49.5	800	54	8	856	1.5

Code	W	L	H	Ø D	A	B	C	X	E
4043.TA050K.033.1	423	134	100	49.5	330	54	8	385	1.5
4043.TA050K.040.1	492	134	100	49.5	400	54	8	456	1.5
4043.TA050K.050.1	592	134	100	49.5	500	54	8	556	1.5
4043.TA050K.060.1	693	134	100	49.5	600	54	8	656	1.5
4043.TA050K.080.1	893	134	100	49.5	800	54	8	856	1.5

PIECE OF	PARTS DESCRIPTION	MATERIAL	PIECE
4043.1	Plastik Vertical Gövde	ABS	1
4043.2	Paslanmaz Üst Gövde	AISI 304	1
4043.3	Height Ayarlı Montaj Seti	PP	2
4043.4	Height Ayarlı Çerçeve	AISI 304	1
4043.5	Paslanmaz Izgara	AISI 304	1
4043.6	Koku Tutucu	ABS	1

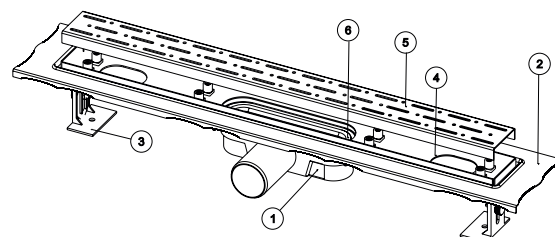

Table measure "mm"

LEGAL 360°

Code	Smart Code	Outlet	Size	Icon	Price \$
4043.00360K.033.1	17920	Ø 50	33 cm	12	46.67
4043.00360K.040.1	17929	Ø 50	40 cm	12	51.33
4043.00360K.050.1	17938	Ø 50	50 cm	12	62.00
4043.00360K.060.1	17947	Ø 50	60 cm	12	66.67
4043.00360K.080.1	17956	Ø 50	80 cm	12	78.67



* Shower drain / Ø 50 side outlet / Stainless body / Adjustable height stainless frame / Odor blocking by water
 * Душевой канал / Ø 50 боковой выход / Корпус Из Нержавеющей С регулировкой высоты / Нержавеющая щетка / Гидрозатвор
 قنائة دش/ هيكل مقاوم للصدأ / مع مخرج ٥٠ ملم / و شبكة مقاومه للصدأ / مع مانع الروائح الكريهة

LEGAL 360° TM

Code	Smart Code	Outlet	Size	Icon	Price \$
4043.T0360K.033.1	27235	Ø 50	33 cm	12	52.33
4043.T0360K.040.1	27236	Ø 50	40 cm	12	61.67
4043.T0360K.050.1	27237	Ø 50	50 cm	12	68.00
4043.T0360K.060.1	27230	Ø 50	60 cm	12	72.67
4043.T0360K.080.1	27238	Ø 50	80 cm	12	83.33



* Shower drain / Ø 50 side outlet / Stainless body / Adjustable height stainless frame / Textile membrane / Odor blocking by water
 * Душевой канал / Ø 50 боковой выход / Корпус Из Нержавеющей / регулируемые по высоте сетки из нержавеющей стали / Текстиль Мембраны / Гидрозатвор
 قنائة دش/ هيكل مقاوم للصدأ / مع مخرج ٥٠ ملم / و شبكة مقاومه للصدأ / مع مانع الروائح الكريهة

LEGAL Y360°

Code	Smart Code	Outlet	Size	Icon	Price \$
4043.0Y360K.033.1	18012	Ø 50	33 cm	12	53.33
4043.0Y360K.040.1	18021	Ø 50	40 cm	12	58.67
4043.0Y360K.050.1	18030	Ø 50	50 cm	12	70.00
4043.0Y360K.060.1	18039	Ø 50	60 cm	12	73.33
4043.0Y360K.080.1	18048	Ø 50	80 cm	12	85.00



* Shower drain / Ø 50 side outlet / Stainless body / Adjustable height stainless frame / Odor blocking by water
 * Душевой канал / Ø 50 боковой выход / Корпус Из Нержавеющей С регулировкой высоты / Нержавеющая щетка / Гидрозатвор
 قنائة دش/ هيكل مقاوم للصدأ / مع مخرج ٥٠ ملم / و شبكة مقاومه للصدأ / مع مانع الروائح الكريهة

LEGAL 360° GOLD

Code	Smart Code	Outlet	Size	Icon	Price \$
4043.00360G.033.1	17966	Ø 50	20 cm	12	52.67
4043.00360G.040.1	17976	Ø 50	33 cm	12	56.67
4043.00360G.050.1	17985	Ø 50	40 cm	12	69.33
4043.00360G.060.1	17994	Ø 50	50 cm	12	74.33
4043.00360G.080.1	18003	Ø 50	60 cm	12	88.00



* Shower drain / Ø 50 side outlet / Stainless body / Adjustable height stainless frame / Odor blocking by water
 * Душевой канал / Ø 50 боковой выход / Корпус Из Нержавеющей С регулировкой высоты / Нержавеющая щетка / Гидрозатвор
 قنائة دش/ هيكل مقاوم للصدأ / مع مخرج ٥٠ ملم / و شبكة مقاومه للصدأ / مع مانع الروائح الكريهة

LEGAL Y360° GOLD

Code	Smart Code	Outlet	Size	Icon	Price \$
4043.0Y360G.033.1	18058	Ø 50	33 cm	12	56.67
4043.0Y360G.040.1	18073	Ø 50	40 cm	12	63.33
4043.0Y360G.050.1	18090	Ø 50	50 cm	12	75.67
4043.0Y360G.060.1	18106	Ø 50	60 cm	12	86.00
4043.0Y360G.080.1	18122	Ø 50	80 cm	12	92.00

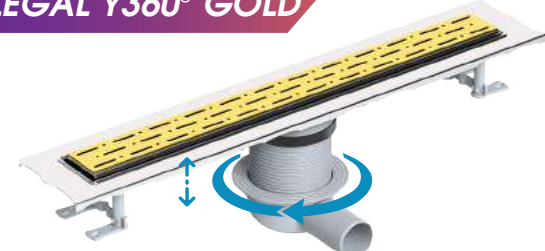

* Shower drain / Ø 50 side outlet / Stainless body / Adjustable height stainless frame / Odor blocking by water
 * Душевой канал / Ø 50 боковой выход / Корпус Из Нержавеющей С регулировкой высоты / Нержавеющая щетка / Гидрозатвор
 قنائة دش/ هيكل مقاوم للصدأ / مع مخرج ٥٠ ملم / و شبكة مقاومه للصدأ / مع مانع الروائح الكريهة



Code Smart Code Outlet Size Price \$ PREMIUM

Code	Smart Code	Outlet	Size		Price \$
4045.0Y050K.033.9	18059	Ø 50	33 cm	12	80.00
4045.0Y050K.045.9	18062	Ø 50	45 cm	12	92.00
4045.0Y050K.060.9	18065	Ø 50	60 cm	12	114.67
4045.0Y050K.080.9	18068	Ø 50	80 cm	12	149.33

* Shower drain / Ø 50 side outlet / Stainless body / Adjustable Height 4 mm Stainless frame / Odor blocking by water
 * Душевой канал / Ø 50 боковой выход / Корпус Из Нержавеющей / С регулировкой высоты 4 mm полное покрытие из нержавеющей / Гидрозатвор
 قنائة دش / هيكل مقاوم للصدأ / مع مخرج ٥٠ ملم / و شبكة مقاومه للصدأ / مع مانع الروائح الكريهة

4045.0A050K.033.9	18070	Ø 50	33 cm	12	80.00
4045.0A050K.045.9	18072	Ø 50	45 cm	12	92.00
4045.0A050K.060.9	18074	Ø 50	60 cm	12	114.67
4045.0A050K.080.9	18076	Ø 50	80 cm	12	149.33

* Shower drain / Ø 50 vertical outlet / Stainless body Adjustable height stainless frame / Odor blocking by water
 * Душевой канал / Ø 50 Нижний выход / Корпус Из Нержавеющей С регулировкой высоты / Нержавеющая щетка / Гидрозатвор
 قنائة دش / هيكل مقاوم للصدأ / مع مخرج ٥٠ ملم / و شبكة مقاومه للصدأ / مع مانع الروائح الكريهة



Code Smart Code Outlet Size Price \$ PREMIUM 360°

Code	Smart Code	Outlet	Size		Price \$
4045.00360K.033.9	18078	Ø 50	33 cm	12	82.49
4045.00360K.045.9	18081	Ø 50	45 cm	12	96.67
4045.00360K.060.9	18083	Ø 50	60 cm	12	116.66
4045.00360K.080.9	18085	Ø 50	80 cm	12	150.00

* Shower drain / Ø 50 side outlet / Stainless body / Adjustable Height 4 mm Stainless frame / Odor blocking by water
 * Душевой канал / Ø 50 боковой выход / Корпус Из Нержавеющей / С регулировкой высоты 4 mm полное покрытие из нержавеющей / Гидрозатвор
 قنائة دش / هيكل مقاوم للصدأ / مع مخرج ٥٠ ملم / و شبكة مقاومه للصدأ / مع مانع الروائح الكريهة

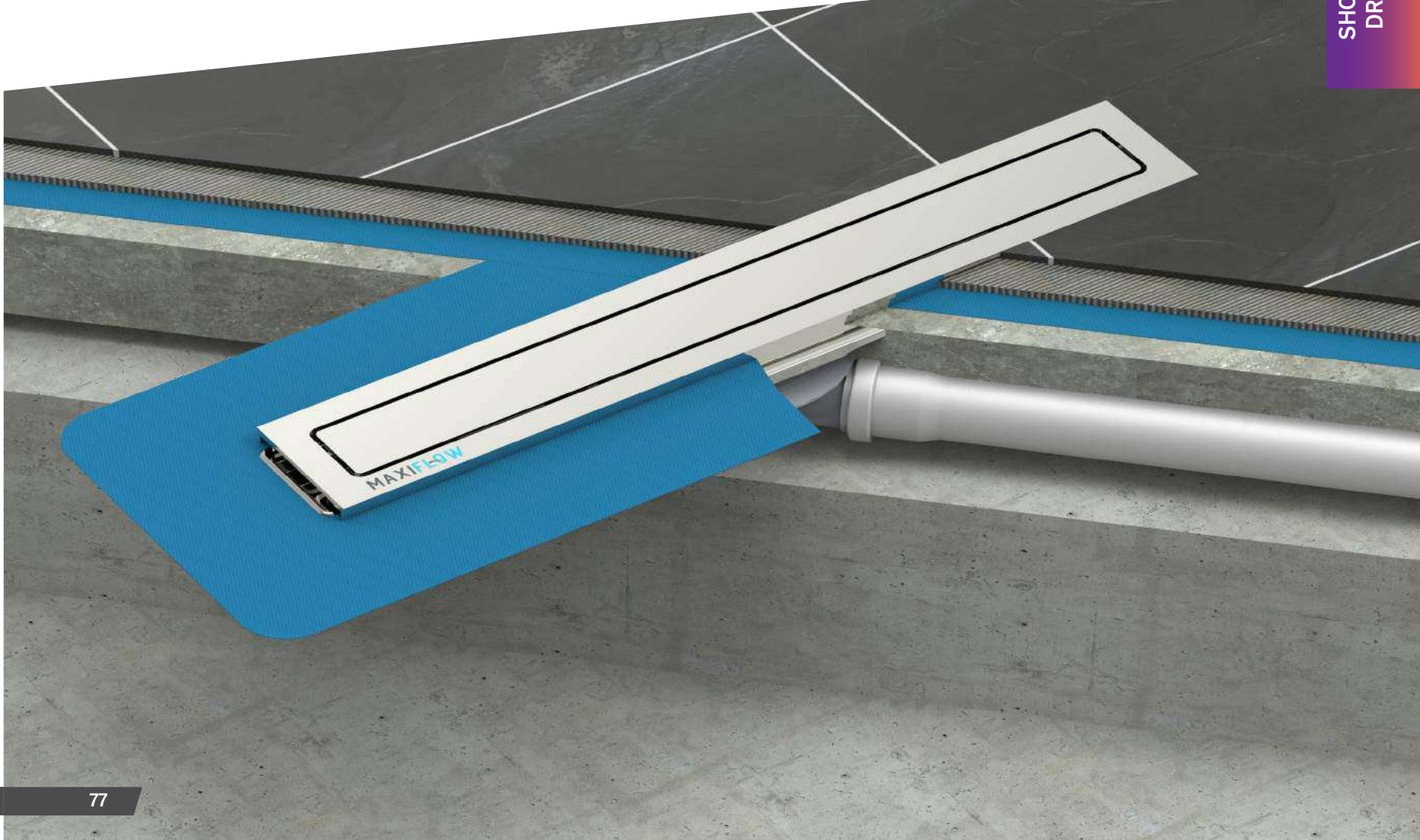

SQUARE SERIES

MAXIFLOW

Code Smart Code Outlet Size Price \$ LINE

4072.0Y050K.020.1	18154	Ø 50	20x20 cm	12	20.00
-------------------	-------	------	----------	----	-------

هيكل بلاستيكي / مع مخرج ٥٠ ملم / و شبكة مقاومه للصدأ / مع مانع الروائح الكريهة



4072.0A050K.020.1	18156	Ø 50	20x20 cm	12	20.00
-------------------	-------	------	----------	----	-------



Code Smart Code Outlet Size Price \$ LEGAL

4073.0Y050K.020.1	18160	Ø 50	20x20 cm	12	36.33
-------------------	-------	------	----------	----	-------

هيكل مقاوم للصدأ / مع مخرج ٥٠ ملم / و شبكة مقاومه للصدأ / مع مانع الروائح الكريهة

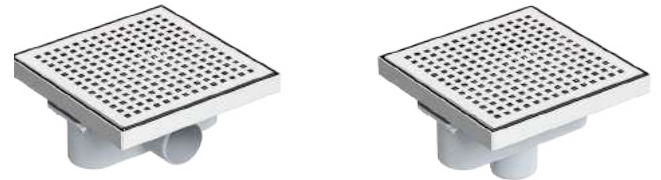

4073.0A050K.020.1	18164	Ø 50	20x20 cm	12	36.33
-------------------	-------	------	----------	----	-------



Code Smart Code Outlet Size Price \$ LEGAL 360°

4073.00360K.020.1	18170	Ø 50	20x20cm	12	36.67
-------------------	-------	------	---------	----	-------

هيكل مقاوم للصدأ / مع مخرج ٥٠ ملم / و شبكة مقاومه للصدأ / مع مانع الروائح الكريهة

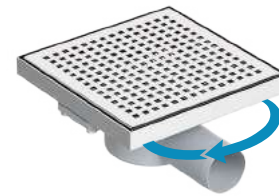

Code Smart Code Outlet Size Price \$ LEGAL Y360°

4073.0Y360K.020.1	18176	Ø 50	20x20cm	12	40.00
-------------------	-------	------	---------	----	-------

هيكل مقاوم للصدأ / مع مخرج ٥٠ ملم / و شبكة مقاومه للصدأ / مع مانع الروائح الكريهة

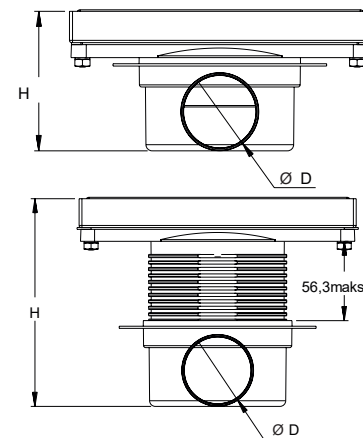
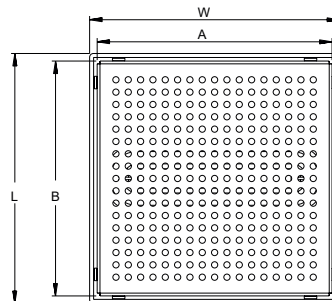
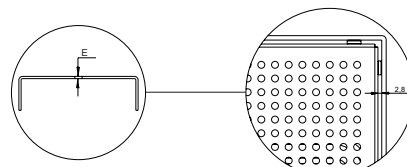
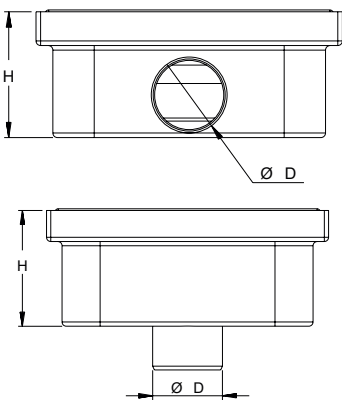
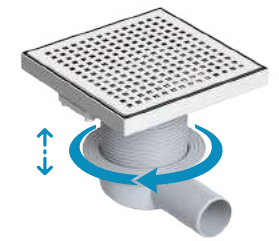

Code	W	L	H	Ø D	A	B	E
4072.0Y050K.020.0	200	200	82	49.5	188	188	1.5

Code	W	L	H	Ø D	A	B	E
4072.0A050K.020.0	200	200	82	49.5	188	188	1.5

Code	W	L	H	Ø D	A	B	E
4073.00360K.020.0	200	200	91	49.5	188	188	1.5

Code	W	L	H	Ø D	A	B	E
4073.0Y360K.020.0	200	200	148	49.5	188	188	1.5

Code Smart Code Outlet Size Price \$ LINE

4062.0Y050K.033.1	18117	Ø 50	33 cm	12	16.67
-------------------	-------	------	-------	----	-------



4062.0A050K.033.1	18121	Ø 50	33 cm	12	16.67
-------------------	-------	------	-------	----	-------

هيكل بلاستيكي / مع مخرج ٥٠ ملم / و شبكة مقاومه للصدأ / مع مانع الروائح الكريهة

Code Smart Code Outlet Size Price \$ LEGAL

4063.0Y050K.033.1	18137	Ø 50	33 cm	12	30.00
-------------------	-------	------	-------	----	-------



4063.0A050K.033.1	18140	Ø 50	33 cm	12	30.00
-------------------	-------	------	-------	----	-------

هيكل بلاستيكي / مع مخرج ٥٠ ملم / و شبكة مقاومه للصدأ / مع مانع الروائح الكريهة

Code Smart Code Outlet Size Price \$ LEGAL 360°

4063.00360K.033.1	18146	Ø 50	33 cm	12	31.67
-------------------	-------	------	-------	----	-------

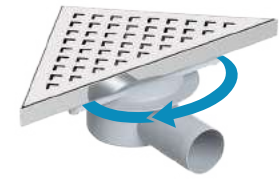

هيكل مقاوم للصدأ / مع مخرج ٥٠ ملم / و شبكة مقاومه للصدأ / مع مانع الروائح الكريهة

Code Smart Code Outlet Size Price \$ LEGAL Y360°

4063.0Y360K.033.1	18150	Ø 50	33 cm	12	35.00
-------------------	-------	------	-------	----	-------

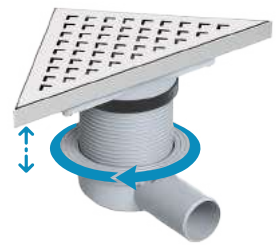

هيكل مقاوم للصدأ / مع مخرج ٥٠ ملم / و شبكة مقاومه للصدأ / مع مانع الروائح الكريهة

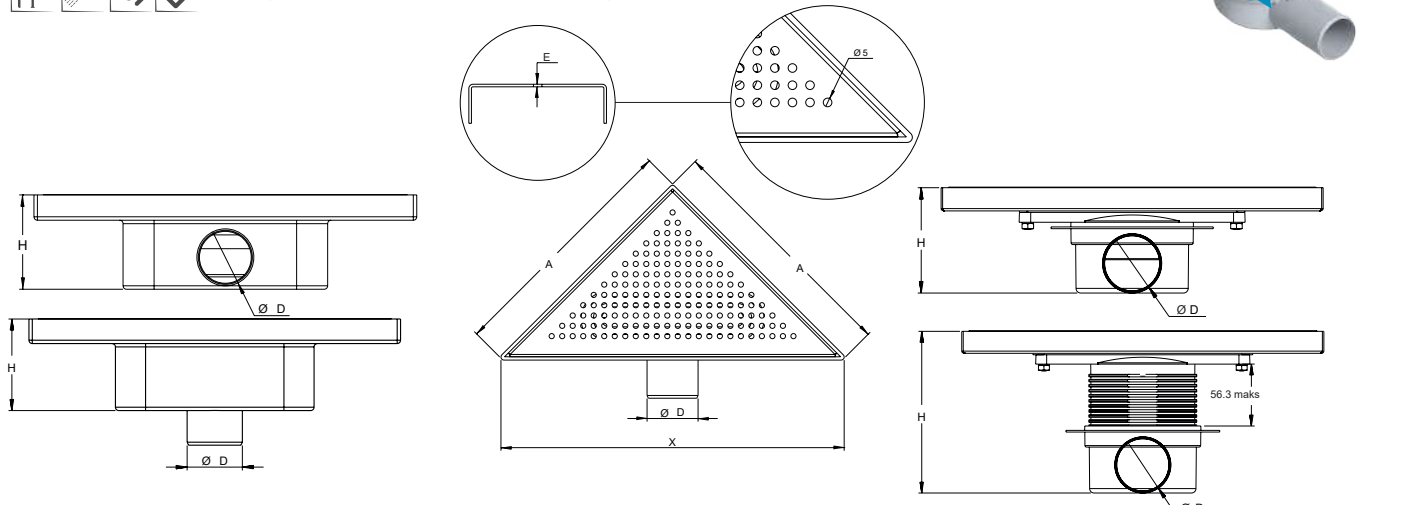

Code	H	Ø D	A	X	E
4062.0Y050K.033.0	84	49.5	234	330	1.5
4062.0A050K.033.0	84	49.5	234	330	1.5

Code	H	Ø D	A	X	E
4063.00360K.033.0	91	49.5	234	330	1.5
4063.0Y360K.033.0	147	49.5	234	330	1.5





EKO 10x10

Code	Smart Code	Outlet	Size	Price \$
3011.0Y050K.010.1	26583	Ø 50	10x10 cm	1.87

*Plastic body / Stainless grid / Odor blocking by water
 *пластичное тело / Нержавеющая решетка / Гидрозатвор
 هيكل بلاستيكي / شبكة مقاومة للصدأ / حابس رائحة مائي بصمام



LINE 10x10

Code	Smart Code	Outlet	Size	Price \$
3012.0Y032K.010.1	13795	Ø 32	10x10 cm	2.83
3012.0Y040K.010.1	13800	Ø 40	10x10 cm	3.17
3012.0Y050K.010.1	13805	Ø 50	10x10 cm	3.00
3012.0Y070K.010.1	13812	Ø 70	10x10 cm	3.33

*Plastic body / Stainless grid / Odor blocking by water
 *пластичное тело / Нержавеющая решетка / Гидрозатвор
 هيكل بلاستيكي / شبكة مقاومة للصدأ / حابس رائحة مائي بصمام



3012.0A040K.010.1	13818	Ø 40	10x10 cm	60	3.33
3012.0A050K.010.1	13826	Ø 50	10x10 cm	60	3.00
3012.0A070K.010.1	13832	Ø 70	10x10 cm	60	3.33

*Plastic body / Stainless grid / Odor blocking by water
 *пластичное тело / Нержавеющая решетка / Гидрозатвор
 هيكل بلاستيكي / شبكة مقاومة للصدأ / حابس رائحة مائي بصمام

ELITE LINE

3012.0Y032K.010.B	28909	Ø 32	10x10 cm	40	3.83
3012.0Y050K.010.B	28910	Ø 50	10x10 cm	40	4.33

هيكل بلاستيكي / شبكة وإطار مقاوم للصدأ / حابس رائحة مائي بصمام / تغليف بليستر

LINE 15x15

Code	Smart Code	Outlet	Size	Price \$
3012.0Y032K.015.1	13882	Ø 32	15x15 cm	4.83
3012.0Y040K.015.1	13888	Ø 40	15x15 cm	5.17
3012.0Y050K.015.1	13896	Ø 50	15x15 cm	5.00
3012.0Y070K.015.1	13903	Ø 70	15x15 cm	5.50

*Plastic body / Stainless grid / Odor blocking by water
 *пластичное тело / Нержавеющая решетка / Гидрозатвор
 هيكل بلاستيكي / شبكة مقاومة للصدأ / حابس رائحة مائي بصمام



3012.0A040K.015.1	13911	Ø 40	15x15 cm	30	5.33
3012.0A050K.015.1	13926	Ø 50	15x15 cm	30	5.00
3012.0A070K.015.1	13933	Ø 70	15x15 cm	30	5.33

*Plastic body / Stainless grid / Odor blocking by water
 *пластичное тело / Нержавеющая решетка / Гидрозатвор
 هيكل بلاستيكي / شبكة مقاومة للصدأ / حابس رائحة مائي بصمام

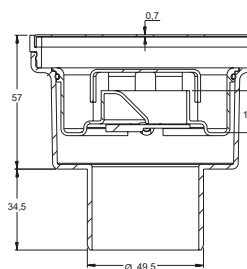
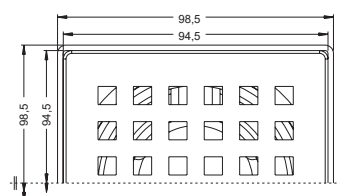
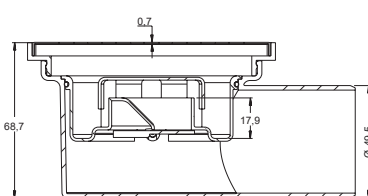
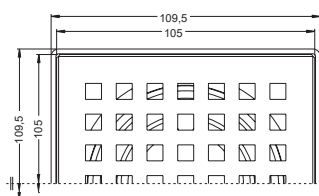

LINE GOLD 10x10

Code	Smart Code	Outlet	Size	Icon	Price \$
3012.0Y032G.010.1	13839	Ø 32	10x10 cm	75	3.83
3012.0Y040G.010.1	13843	Ø 40	10x10 cm	50	4.17
3012.0Y050G.010.1	13848	Ø 50	10x10 cm	50	4.00
3012.0Y070G.010.1	13853	Ø 70	10x10 cm	30	4.33

*Plastic body / Stainless grid / Odor blocking by water
 *пластичное тело / Нержавеющая решетка / Гидрозатвор
 هيكل بلاستيكي / شبكة مقاومة للصدأ / حابس رائحة مائي بصمام

3012.0A040G.010.1	13859	Ø 40	10x10 cm	60	4.00
3012.0A050G.010.1	13868	Ø 50	10x10 cm	60	3.83
3012.0A070G.010.1	13873	Ø 70	10x10 cm	50	4.00

*Plastic body / Stainless grid / Odor blocking by water
 *пластичное тело / Нержавеющая щетка / Гидрозатвор
 هيكل بلاستيكي / شبكة مقاومة للصدأ / حابس رائحة مائي بصمام

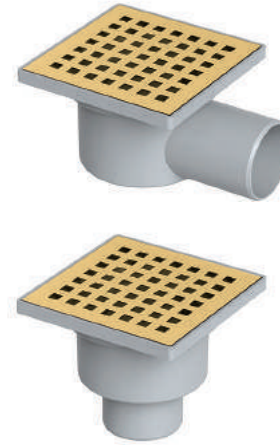

LINE GOLD 15x15

Code	Smart Code	Outlet	Size	Icon	Price \$
3012.0Y032G.015.1	13884	Ø 32	15x15 cm	40	6.33
3012.0Y040G.015.1	13892	Ø 40	15x15 cm	30	6.67
3012.0Y050G.015.1	13904	Ø 50	15x15 cm	30	6.50
3012.0Y070G.015.1	13912	Ø 70	15x15 cm	20	7.00

*Plastic body / Stainless grid / Odor blocking by water
 *пластичное тело / Нержавеющая щетка / Гидрозатвор
 هيكل بلاستيكي / شبكة مقاومة للصدأ / حابس رائحة مائي بصمام

3012.0A040G.015.1	13917	Ø 40	15x15 cm	30	6.67
3012.0A050G.015.1	13923	Ø 50	15x15 cm	30	6.50
3012.0A070G.015.1	13930	Ø 70	15x15 cm	30	6.67

*Plastic body / Stainless grid / Odor blocking by water
 *пластичное тело / Нержавеющая щетка / Гидрозатвор
 هيكل بلاستيكي / شبكة مقاومة للصدأ / حابس رائحة مائي بصمام

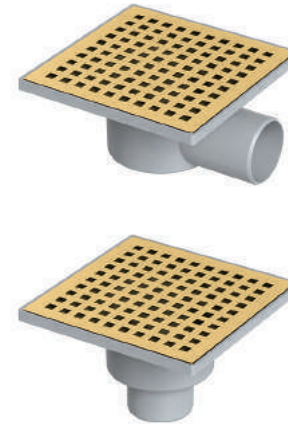

Details

DN 50 side and vertical outlet - compatible with PVC pipe connections, blocking odor by water (36mm). The flow rate is 32 liters/min. Resistant against external chemical effects, operating temperature is between -30°C and +75°C. The grid is made of 304 grade stainless steel.

Advantages

With its 304 grade stainless steel grid, it has a quality and stylish-looking. It can be easily applied at floor. With its odor blocking by water support, it prevents the bad smell coming from the installation. With its adjustable height legs, it can be adjusted depending on the screed concrete. High resistance against the organic and inorganic chemicals, resistant against most acidic and vertically aqueous oxidation.

Areas of Usage

Common use of bathroom shower, hospital and hotel shower areas, locker-room shower areas etc.

Customized Production

Grid patterns can be chosen. In gold, bronze or other optional colors in accordance with your desire.

Warning

It is not recommended to use high-density cleaners for a long time.

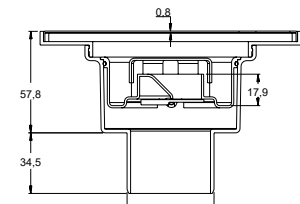
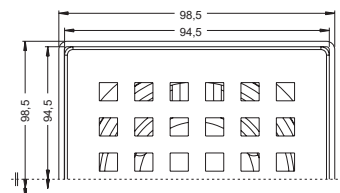
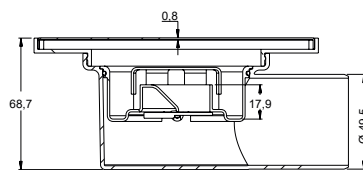
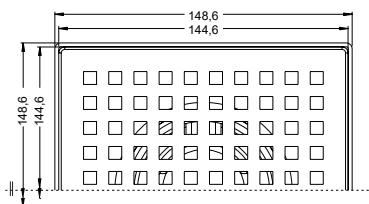

SQUARE
81

ENDEKS



LEGAL 10x10

Code	Smart Code	Outlet	Size	Icon	Price \$
3013.0Y032K.010.1	13940	Ø 32	10x10 cm	75	5.33
3013.0Y040K.010.1	13950	Ø 40	10x10 cm	50	5.52
3013.0Y050K.010.1	13960	Ø 50	10x10 cm	50	5.50
3013.0Y070K.010.1	13969	Ø 70	10x10 cm	30	5.67

*Plastic body / Stainless grid / Stainless frame / Odor blocking with vet and dry system
 *пластичное тело / Нержавеющая решетка и рама / Гидрозатвор
 هيكل بلاستيكي / شبكة وإطار مقاوم للصدأ / حابس رائحة مائي بصمام

3013.0A040K.010.1	13976	Ø 40	10x10 cm	60	5.67
3013.0A050K.010.1	13990	Ø 50	10x10 cm	60	5.33
3013.0A070K.010.1	13998	Ø 70	10x10 cm	60	5.67

*Plastic body / Stainless grid / Stainless frame / Odor blocking by water
 *пластичное тело / Нержавеющая решетка и рама / Гидрозатвор
 هيكل بلاستيكي / شبكة وإطار مقاوم للصدأ / حابس رائحة مائي بصمام



ELITE LEGAL

3013.0Y032K.010.B	28911	Ø 32	10x10 cm	40	5.83
3013.0Y050K.010.B	28912	Ø 50	10x10 cm	40	6.00

هيكل بلاستيكي / شبكة وإطار مقاوم للصدأ / حابس رائحة مائي بصمام / تغليف بليستر

LEGAL 15x15

3013.0Y032K.015.1	13949	Ø 32	15x15 cm	40	8.00
3013.0Y040K.015.1	13968	Ø 40	15x15 cm	30	8.17
3013.0Y050K.015.1	13977	Ø 50	15x15 cm	30	8.00
3013.0Y070K.015.1	13981	Ø 70	15x15 cm	20	8.50

*Plastic body / Stainless grid / Stainless frame / Odor blocking with vet and dry system
 *пластичное тело / Нержавеющая решетка и рама / Гидрозатвор
 هيكل بلاستيكي / شبكة وإطار مقاوم للصدأ / حابس رائحة مائي بصمام

3013.0A040K.015.1	13989	Ø 40	15x15 cm	30	8.33
3013.0A050K.015.1	13996	Ø 50	15x15 cm	30	7.85
3013.0A070K.015.1	14006	Ø 70	15x15 cm	30	8.33

*Plastic body / Stainless grid / Stainless frame / Odor blocking by water
 *пластичное тело / Нержавеющая решетка и рама / Гидрозатвор
 هيكل بلاستيكي / شبكة وإطار مقاوم للصدأ / حابس رائحة مائي بصمام



FLOOR DRAINS

Details

DN 50 side and vertical outlet - compatible with PVC pipe connections, blocking odor by water (36mm). The flow rate is 32 liters/min. Resistant against external chemical effects, operating temperature is between -30°C and +75°C. The grid is made of 304 grade stainless steel.

Advantages

With its 304 grade stainless steel grid, it has a quality and stylish-looking. It can be easily applied at floor. With its odor blocking by water support, it prevents the bad smell coming from the installation. With its adjustable height legs, it can be adjusted depending on the screed concrete. High resistance against the organic and inorganic chemicals, resistant against most acidic and vertically aqueous oxidation.

Areas of Usage

Common use of bathroom shower, hospital and hotel shower areas, locker-room shower areas etc.

Customized Production

Grid patterns can be chosen in gold, bronze or other optional colors in accordance with your desire.

Warning

It is not recommended to use high-density cleaners for a long time.

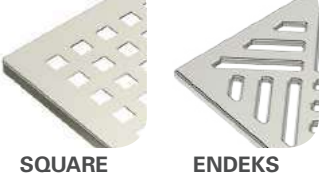
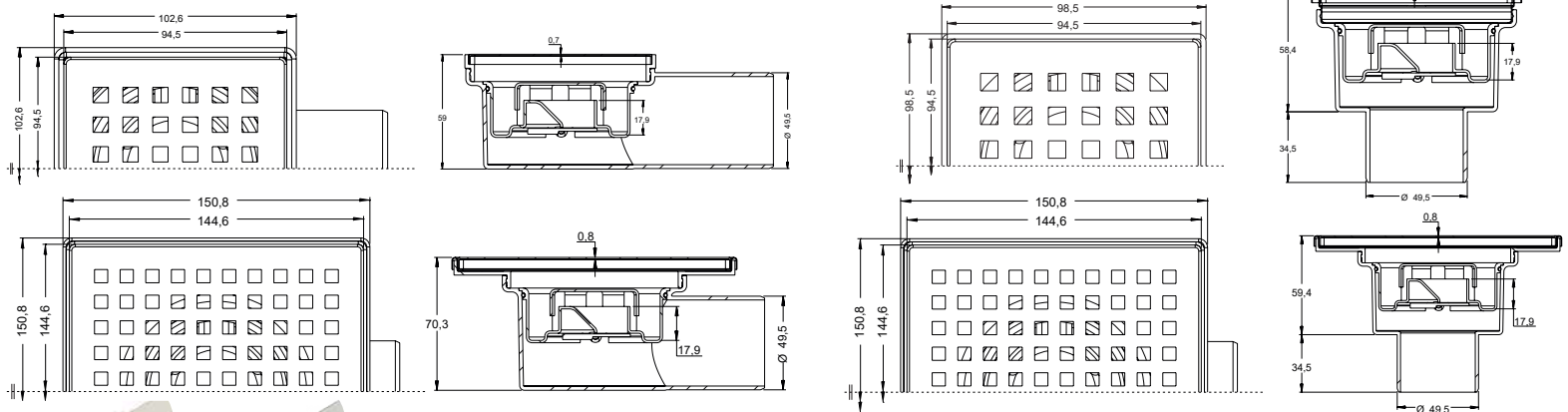

KUCA

Code	Smart Code	Outlet	Size		Price \$
5710.0A050K.010.1	13939	Ø 50	10x10 cm	60	3.67
5710.0A070K.010.1	13941	Ø 70	10x10 cm	60	3.83



*Plastic body / Stainless grid

*пластичное тело / Нержавеющая решетка
هيكل بلاستيكي / شبكة مقاومة للصدأ

SCALA 10x10

Code	Smart Code	Outlet	Size		Price \$
3014.0Y032K.010.9	14005	Ø 32	10x10 cm	50	3.66
3014.0Y050K.010.9	14011	Ø 50	10x10 cm	50	4.00



*Plastic body / Stainless steel grid and frame / Odor blocking by water

*пластичное тело / Нержавеющая решетка и рама / Гидрозатвор
هيكل بلاستيكي / شبكة وإطار مقاوم للصدأ / حابس رائحة مائي بصمام

3014.0A050K.010.9	14013	Ø 50	10x10 cm	50	4.00
-------------------	-------	------	----------	----	------

*Plastic body / Stainless steel grid and frame / Odor blocking by water

*пластичное тело / Нержавеющая решетка и рама / Гидрозатвор
هيكل بلاستيكي / شبكة وإطار مقاوم للصدأ / حابس رائحة مائي بصمام

SCALA 15x15

Code	Smart Code	Outlet	Size		Price \$
3014.0Y032K.015.9	14014	Ø 32	15x15 cm	30	5.17
3014.0Y050K.015.9	14015	Ø 50	15x15 cm	30	5.33



*Plastic body / Stainless steel grid and frame / Odor blocking by water

*пластичное тело / Нержавеющая решетка и рама / Гидрозатвор
هيكل بلاستيكي / شبكة وإطار مقاوم للصدأ / حابس رائحة مائي بصمام

3014.0A050K.015.9	14017	Ø 50	15x15 cm	24	5.33
-------------------	-------	------	----------	----	------

*Plastic body / Stainless steel grid and frame / Odor blocking by water

*пластичное тело / Нержавеющая решетка и рама / Гидрозатвор
هيكل بلاستيكي / شبكة وإطار مقاوم للصدأ / حابس رائحة مائي بصمام

KÖŞE BALKON

Code	Smart Code	Outlet		Price \$
6001.0A070.13.0	13942	Ø 70	125	4.67



Plastic body
пластичное тело
هيكل بلاستيكي

6002.0A100.16.0	13945	Ø 100	64	5.00
-----------------	-------	-------	----	------

Plastic body
пластичное тело
هيكل بلاستيكي



MIDI 10x10

Code	Smart Code	Outlet	Size	Icon	Price \$
5001.0Y032.010.1	14010	Ø 32	10x10 cm	30	4.67
5001.0Y040.010.1	14018	Ø 40	10x10 cm	20	5.33
5001.0Y050.010.1	14022	Ø 50	10x10 cm	20	4.83
5001.0Y070.010.1	14025	Ø 70	10x10 cm	20	5.33
<hr/>					
5001.0A040.010.1	14032	Ø 40	10x10 cm	20	5.00
5001.0A050.010.1	14035	Ø 50	10x10 cm	20	4.83
5001.0A070.010.1	14039	Ø 70	10x10 cm	20	5.00



Plastic body, Ss Grid/ Odor trap
 пластичное тело / Нержавеющая решетка / Мокрый Затвор
 هيكل بلاستيكي / شبكة مقاومه للصدأ / حابس رائحة كريهه بصمام

STD. 10x10

Code	Smart Code	Outlet	Size	Icon	Price \$
5002.0Y032.010.1	14019	Ø 32	10x10 cm	30	6.67
5002.0Y040.010.1	14041	Ø 40	10x10 cm	20	7.51
5002.0Y050.010.1	14046	Ø 50	10x10 cm	20	7.50
5002.0Y070.010.1	14050	Ø 70	10x10 cm	20	8.00
5002.0Y100.010.1	14052	Ø 100	10x10 cm	10	9.17
<hr/>					
5002.0A040.010.1	14062	Ø 40	10x10 cm	20	7.50
5002.0A050.010.1	14067	Ø 50	10x10 cm	20	7.50
5002.0A070.010.1	14078	Ø 70	10x10 cm	20	7.50
5002.0A100.010.1	14083	Ø 100	10x10 cm	10	7.83



Plastic body, Ss Grid/ Odor trap
 пластичное тело / Нержавеющая решетка / Мокрый Затвор
 هيكل بلاستيكي / شبكة مقاومه للصدأ / حابس رائحة كريهه بصمام

MESH 10x10

Code	Smart Code	Outlet	Size	Icon	Price \$
5002.FY032.010.1	14059	Ø 32	10x10 cm	30	7.67
5002.FY040.010.1	14055	Ø 40	10x10 cm	20	8.00
5002.FY050.010.1	14061	Ø 50	10x10 cm	20	8.00
5002.FY070.010.1	14068	Ø 70	10x10 cm	20	8.18
5002.FY100.010.1	14073	Ø 100	10x10 cm	10	8.67
<hr/>					
5002.FA040.010.1	14077	Ø 40	10x10 cm	20	7.67
5002.FA050.010.1	14084	Ø 50	10x10 cm	20	7.67
5002.FA070.010.1	14088	Ø 70	10x10 cm	20	7.67
5002.FA100.010.1	14093	Ø 100	10x10 cm	10	8.00

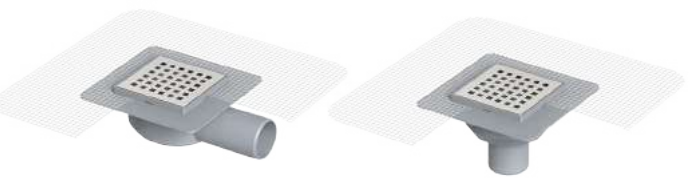

Plastic body, Ss Grid/ Odor trap/Mesh
 пластичное тело / Нержавеющая решетка / Мокрый Затвор/Сеть
 هيكل بلاستيكي / شبكة مقاومه للصدأ / حابس رائحة كريهه بصمام

TEKSTIL MEMBRANE 10X10

Code	Smart Code	Outlet	Size	Icon	Price \$
5002.TY032.010.1	14091	Ø 32	10x10 cm	30	8.33
5002.TY040.010.1	14103	Ø 40	10x10 cm	20	8.33
5002.TY050.010.1	14107	Ø 50	10x10 cm	20	8.33
5002.TY070.010.1	14112	Ø 70	10x10 cm	20	8.67
5002.TY100.010.1	14120	Ø 100	10x10 cm	10	9.00
<hr/>					
5002.TA040.010.1	14124	Ø 40	10x10 cm	20	8.33
5002.TA050.010.1	14128	Ø 50	10x10 cm	20	8.33
5002.TA070.010.1	14132	Ø 70	10x10 cm	20	8.33
5002.TA100.010.1	14136	Ø 100	10x10 cm	10	8.67

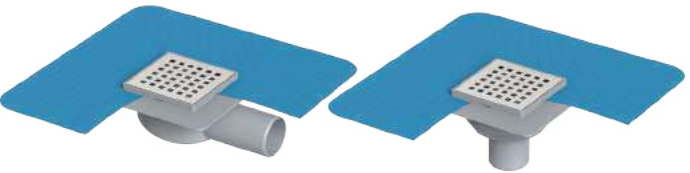

Plastic body, Ss Grid/ Odor trap/Membrane
 пластичное тело / Нержавеющая решетка / Мокрый Затвор/Мембраны
 هيكل بلاستيكي / شبكة مقاومه للصدأ / حابس رائحة كريهه بصمام

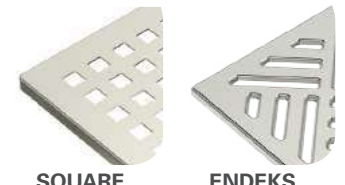

SQUARE

ENDEKS

STAINLESS FLOOR DRAINS

MAXIFLOW

PREMIUM 10x10

Code	Smart Code	Outlet	Size	Icon	Price \$
3045.0Y032K.010.1	14096	Ø 32	10x10 cm	24	14.00
3045.0Y050K.010.1	14097	Ø 50	10x10 cm	24	14.67
3045.0A050K.010.1	14099	Ø 50	10x10 cm	24	12.67

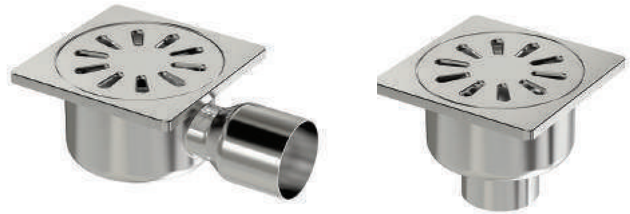

*Stainless body / Stainless steel grid / Stainless scent holder
 *Корпус Из Нержавеющей / Нержавеющая решетка / Гидрозатвор
 هيكل مقاوم للصدأ / شبكة مقاومة للصدأ / حابس رائحة غير القابل للصدأ

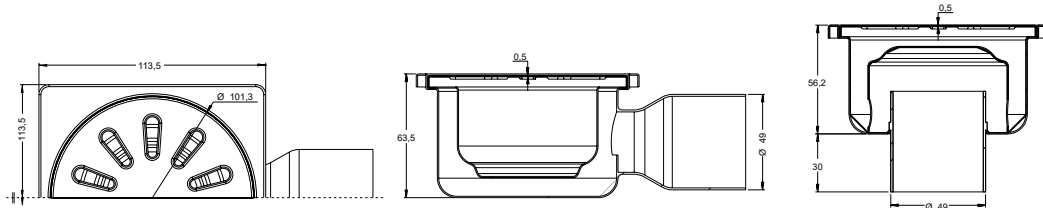

PREMIUM 15x15

Code	Smart Code	Outlet	Size	Icon	Price \$
3045.0Y032K.015.1	14100	Ø 32	15x15 cm	24	15.33
3045.0Y050K.015.1	14102	Ø 50	15x15 cm	24	16.67
3045.0Y070K.015.1	14104	Ø 70	15x15 cm	24	18.33
3045.0A050K.015.1	14108	Ø 50	15x15 cm	24	16.00
3045.0A070K.015.1	14111	Ø 70	15x15 cm	24	18.33



*Stainless body / Stainless steel grid / Stainless scent holder
 *Корпус Из Нержавеющей / Нержавеющая решетка / Гидрозатвор
 هيكل مقاوم للصدأ / شبكة مقاومة للصدأ / حابس رائحة غير القابل للصدأ

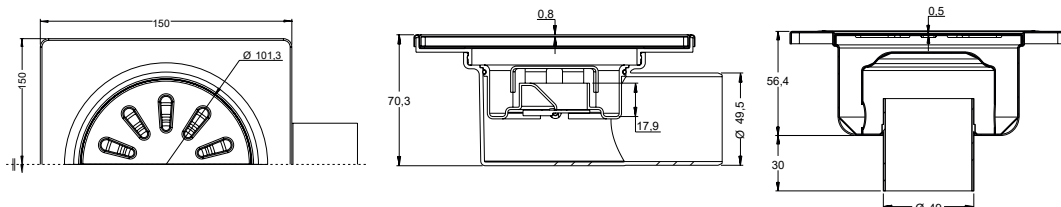

PREMIUM 20x20

Code	Smart Code	Outlet	Size	Icon	Price \$
3045.0Y070K.020.1	14115	Ø 70	20x20 cm	12	53.33
3045.0Y100K.020.1	14116	Ø 100	20x20 cm	12	56.67
3045.0A070K.020.1	14117	Ø 70	20x20 cm	12	53.33
3045.0A100K.020.1	14119	Ø 100	20x20 cm	12	56.67

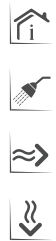

*Stainless body / Stainless steel grid / Stainless scent holder
 *Корпус Из Нержавеющей / Нержавеющая решетка / Гидрозатвор
 هيكل مقاوم للصدأ / شبكة مقاومة للصدأ / حابس رائحة غير القابل للصدأ

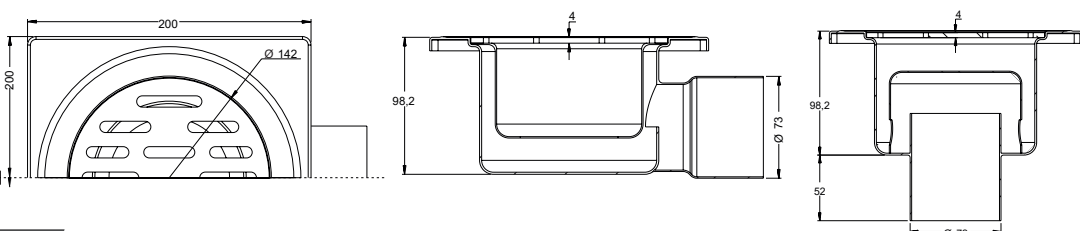

FLOOR
DRAINS

Code Smart Code Outlet Length Price \$ LIBRA 10x10

3065.0A050K.10.1 21339 Ø 50 10x10 cm 50 14.67

قناة دش / هيكل مقاوم للصدأ / مع مخرج متحرك ٥٠ ملم / و غطاء مقاوم للصدأ من اجل السيراميك / مع مانع الروائح الكريهة



3065.0Y050K.10.1 21333 Ø 50 10x10 cm 50 16.67

قناة دش / هيكل مقاوم للصدأ / مع مخرج متحرك ٥٠ ملم / و غطاء مقاوم للصدأ من اجل السيراميك / مع مانع الروائح الكريهة

Stainless Steel Body / Tile Insertable Grid



3066.0Y050K.10.1 26683 Ø 50 10x10 cm 50 16.33

قناة دش / هيكل مقاوم للصدأ / مع مخرج متحرك ٥٠ ملم / و غطاء مقاوم للصدأ من اجل السيراميك / مع مانع الروائح الكريهة

Stainless Steel Body / Tile Insertable Grid



Code Smart Code Outlet Length Price \$ LIBRA 15x15

3065.0A050K.015.1 21353 Ø 50 15x15 cm 50 20.00

قناة دش / هيكل مقاوم للصدأ / مع مخرج متحرك ٥٠ ملم / و غطاء مقاوم للصدأ من اجل السيراميك / مع مانع الروائح الكريهة



Stainless Steel Body / Tile Insertable Grid

3065.0Y050K.015.1 21347 Ø 50 15x15 cm 50 21.33

قناة دش / هيكل مقاوم للصدأ / مع مخرج متحرك ٥٠ ملم / و غطاء مقاوم للصدأ من اجل السيراميك / مع مانع الروائح الكريهة

Stainless Steel Body / Tile Insertable Grid



3014.0A050K.010.9 26685 Ø 50 15x15 cm 50 20.67

قناة دش / هيكل مقاوم للصدأ / مع مخرج متحرك ٥٠ ملم / و غطاء مقاوم للصدأ من اجل السيراميك / مع مانع الروائح الكريهة

Stainless Steel Body / Tile Insertable Grid



Code Smart Code Outlet Size Price \$ P. SLIM 10x10

3046.0Y040K.010.1	14127	Ø 40	10x10 cm	50	14.67
3046.0Y050K.010.1	14130	Ø 50	10x10 cm	50	16.00
3046.0A040K.010.1	14134	Ø 40	10x10 cm	50	12.17
3046.0A050K.010.1	14137	Ø 50	10x10 cm	50	13.00

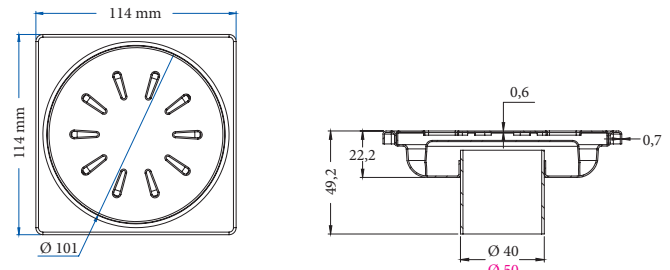
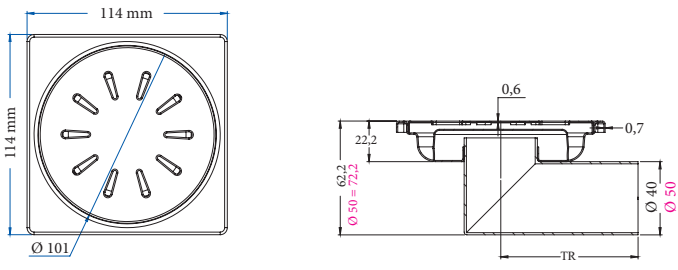

*Stainless body / Stainless steel grid / Stainless scent holder
 *Корпус Из Нержавеющей / Нержавеющая решетка / Гидрозатвор
 هيكل مقاوم للصدأ / شبكة مقاومة للصدأ / حابس رائحة غير القابل للصدأ

Code Smart Code Outlet Size Price \$ P. SLIM 15x15

3046.0Y040K.015.1	14143	Ø 40	15x15 cm	50	17.00
3046.0Y050K.015.1	14144	Ø 50	15x15 cm	50	17.50
3046.0A040K.015.1	14145	Ø 40	15x15 cm	50	13.67
3046.0A050K.015.1	14147	Ø 50	15x15 cm	50	14.32

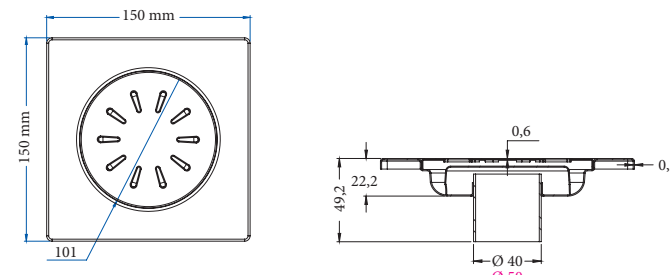
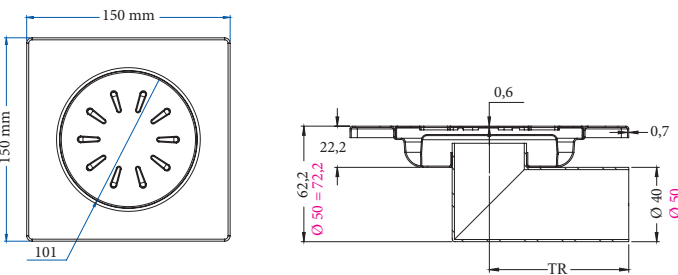

*Stainless body / Stainless steel grid / Stainless scent holder
 *Корпус Из Нержавеющей / Нержавеющая решетка / Гидрозатвор
 هيكل مقاوم للصدأ / شبكة مقاومة للصدأ / حابس رائحة غير القابل للصدأ

Code Smart Code Outlet Size Price \$ P. SLIM 20x20

3046.0Y040K.020.1	14148	Ø 40	20x20 cm	24	36.67
3046.0Y050K.020.1	14149	Ø 50	20x20 cm	24	37.00
3046.0A040K.020.1	14150	Ø 40	20x20 cm	24	29.33
3046.0A050K.020.1	14151	Ø 50	20x20 cm	24	30.00

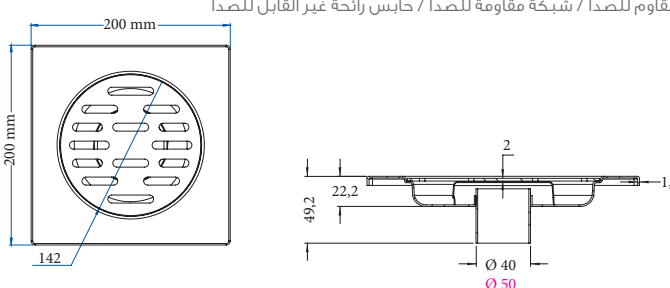
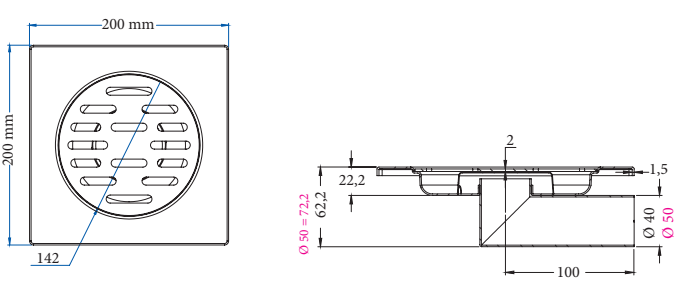

*Stainless body / Stainless steel grid / Stainless scent holder
 *Корпус Из Нержавеющей / Нержавеющая решетка / Гидрозатвор
 هيكل مقاوم للصدأ / شبكة مقاومة للصدأ / حابس رائحة غير القابل للصدأ

Code Smart Code Length Price \$ PEARL

3155.1515P0.120.0	14152	Without lap	1.20 mm	15x15 cm	50	8.33
3155.1515P0.150.0	14153	Without lap	1.50 mm	15x15 cm	50	10.00
3155.1515P1.120.0	14155	With lap	1.20 mm	15x15 cm	50	9.00
3155.1515P1.150.0	14156	With lap	1.50 mm	15x15 cm	50	10.50
3155.2020P0.150.0	14154	Without lap	1.50 mm	20x20 cm	40	14.67
3155.2020P1.150.0	14157	With lap	1.50 mm	20x20 cm	40	14.50



Stainless body / Корпус Из Нержавеющей
هيكل مقاوم للصدأ

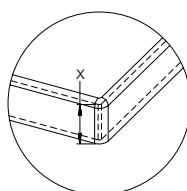
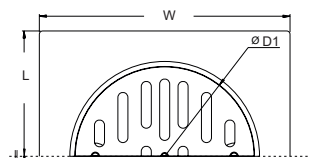

Code	W	L	H	Ø D	Ø D1	E	E1	X
3155.1515P0.120.0	150	150	13	102.5	107	1.2	1.2	-
3155.1515P0.150.0	150	150	13	102.5	107	1.5	1.5	-
3155.1515P1.120.0	150	150	13	102.5	107	1.2	1.2	7.8
3155.1515P1.150.0	150	150	13	102.5	107	1.5	1.5	7.8
3155.2020P0.150.0	200	150	13	102.5	107	1.2	1.2	-
3155.2020P1.150.0	200	150	13	102.5	107	1.5	1.5	7.8

Code Smart Code Length Price \$ QUATTRO

3159.1515P0.120.0	14158	Without lap	1.20 mm	15x15 cm	50	11.00
3159.1515P0.150.0	14159	Without lap	1.50 mm	15x15 cm	50	12.83
3159.1515P1.120.0	14161	With lap	1.20 mm	15x15 cm	50	11.33
3159.1515P1.150.0	14162	With lap	1.50 mm	15x15 cm	50	13.67
3159.2020P0.150.0	14160	Without lap	1.50 mm	20x20 cm	40	18.33
3159.2020P1.150.0	14163	With lap	1.50 mm	20x20 cm	40	19.33



Stainless body / Корпус Из Нержавеющей
هيكل مقاوم للصدأ

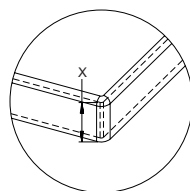
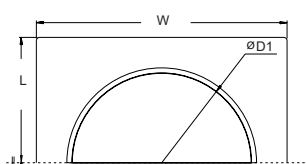

Code	W	L	H	Ø D	Ø D1	E	E1	X
3159.1515P0.120.0	150	150	13	102.5	107	1.2	1.2	-
3159.1515P0.150.0	150	150	13	102.5	107	1.5	1.5	-
3159.1515P1.120.0	150	150	13	102.5	107	1.2	1.2	7.8
3159.1515P1.150.0	150	150	13	102.5	107	1.5	1.5	7.8
3159.2020P0.150.0	200	150	13	102.5	107	1.2	1.2	-
3159.2020P1.150.0	200	150	13	102.5	107	1.5	1.5	7.8

Code Smart Code Length Price \$ DREAM

3158.1515P0.120.0	14168	Without lap	1.20 mm	15x15 cm	50	10.83
3158.1515P0.150.0	14171	Without lap	1.50 mm	15x15 cm	50	12.67
3158.1515P1.120.0	14174	With lap	1.20 mm	15x15 cm	50	11.33
3158.1515P1.150.0	14175	With lap	1.50 mm	15x15 cm	50	13.33
3158.2020P0.150.0	14173	Without lap	1.50 mm	20x20 cm	40	18.33
3158.2020P1.150.0	14176	With lap	1.50 mm	20x20 cm	40	19.00



Stainless body / Корпус Из Нержавеющей
هيكل مقاوم للصدأ

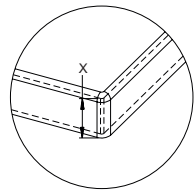
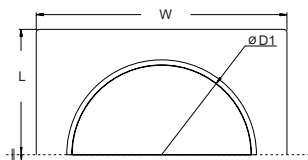

Code	W	L	H	Ø D	Ø D1	E	E1	X
3158.1515P0.120.0	150	150	13	102.5	107	1.2	1.2	-
3158.1515P0.150.0	150	150	13	102.5	107	1.5	1.5	-
3158.1515P1.120.0	150	150	13	102.5	107	1.2	1.2	7.8
3158.1515P1.150.0	150	150	13	102.5	107	1.5	1.5	7.8
3158.2020P0.150.0	200	150	13	102.5	107	1.2	1.2	-
3158.2020P1.150.0	200	150	13	102.5	107	1.5	1.5	7.8

Code Smart Code Length Price \$ NILE

3156.1515P0.120.0	14178	Without lap	1.20 mm	15x15 cm	50	7.67
3156.1515P0.150.0	14180	Without lap	1.50 mm	15x15 cm	50	9.00
3156.1515P1.120.0	14182	With lap	1.20 mm	15x15 cm	50	8.33
3156.1515P1.150.0	14183	With lap	1.50 mm	15x15 cm	50	9.67
3156.2020P0.150.0	14181	Without lap	1.50 mm	15x15 cm	40	13.33
3156.2020P1.150.0	14184	With lap	1.50 mm	15x15 cm	40	16.00



Stainless body / Корпус Из Нержавеющей
هيكل مقاوم للصدأ

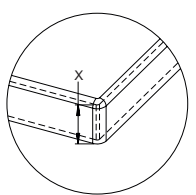
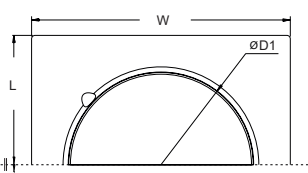

Code	W	L	H	Ø D	Ø D1	E	E1	X
3156.1515P0.120.0	150	150	13	102.5	107	1.2	1.2	-
3156.1515P0.150.0	150	150	13	102.5	107	1.5	1.5	-
3156.1515P1.120.0	150	150	13	102.5	107	1.2	1.2	7.8
3156.1515P1.150.0	150	150	13	102.5	107	1.5	1.5	7.8
3156.2020P0.150.0	200	150	13	102.5	107	1.2	1.2	-
3156.2020P1.150.0	200	150	13	102.5	107	1.5	1.5	7.8

SIPHON UPPER BODY

MAXIFLOW

Code	Smart Code	Dia	Size		Price \$	LINE
------	------------	-----	------	---	----------	------

10X10

5101.0A100.10.1	14198	Ø 100	10x10 cm	150	6.00
-----------------	-------	-------	----------	-----	------

15X15

5107.0A100.15.1	14200	Ø 100	15x15 cm	80	8.00
-----------------	-------	-------	----------	----	------



*Plastic body / Stainless steel grid / Odor blocking by waters
 *пластичное тело / Гидро и сухой затвор / Нержавеющая решетка
 هيكل بلاستيكي / شبكة مقاومة للصدأ / حابس رائحة بصمام مائي

Code	Smart Code	Dia	Size		Price \$	LEGAL
------	------------	-----	------	---	----------	-------

10X10

5102.0A100.10.1	14204	Ø 100	10x10 cm	150	6.67
-----------------	-------	-------	----------	-----	------

15X15

5108.0A100.15.1	14206	Ø 100	15x15 cm	80	9.00
-----------------	-------	-------	----------	----	------



*Plastic body / Stainless steel grid and frame / Odor blocking by waters
 *пластичное тело / Гидро и сухой затвор / Решетка из нержавеющей стали и рамка
 هيكل بلاستيكي / شبكة وإطار مقاوم للصدأ / حابس رائحة بصمام مائي

Code	Smart Code	Dia	Size		Price \$	PREMIUM
------	------------	-----	------	---	----------	---------

10X10

5105.0A100.10.0	14207	Ø 100	10x10 cm	120	7.67
-----------------	-------	-------	----------	-----	------

15X15

5111.0A100.15.0	14209	Ø 100	15x15 cm	80	9.00
-----------------	-------	-------	----------	----	------



*Plastic body / Stainless steel outer frame and full cover / Odor blocking by water
 *пластичное тело / Гидро и сухой затвор Рама из нержавеющей стали и полное покрытие
 هيكل بلاستيكي / الإطار الخارجي الفولاذ المقاوم للصدأ والغطاء الكامل حابس رائحة بصمام مائي

Code	Smart Code	Dia	Size		Price \$	RING
------	------------	-----	------	---	----------	------

RING

1207001100100	14208	Ø 100	-	150	2.17
---------------	-------	-------	---	-----	------

IZGARALI RING

5112.0A100.00.1	14210	Ø 100	15x15 cm	150	4.67
-----------------	-------	-------	----------	-----	------



SQUARE

ENDEKS

SIPHON UPPER BODY

MAXIFLOW

Code Smart Code Dia Size Price \$ SCALA 10x10

5103.0A100.10.0 14199 Ø 100 10x10 cm 120 3.00

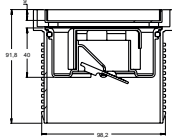
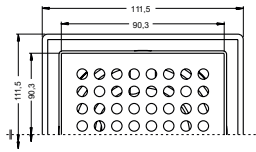

*Plastic body / Odor blocking by water / Compatible with ceramic Plastic interior frame
 *пластичное тело / Сухой Затвор
 هيكل بلاستيكي / حابس رائحة بصمام مائي / متوافق مع السيراميك إطار الداخلية من البلاستيك

Code Smart Code Dia Size Price \$ SCALA 15x15

5109.0A100.15.0 14202 Ø 100 15x15 cm 80 3.33

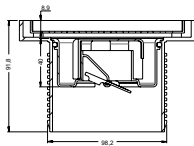
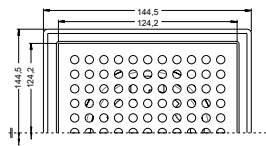

*Plastic body / Odor blocking by water / Compatible with ceramic Plastic interior frame
 *пластичное тело / Сухой Затвор
 هيكل بلاستيكي / حابس رائحة بصمام مائي / متوافق مع السيراميك إطار الداخلية من البلاستيك

Code Smart Code Dia Size Price \$ ELIT 10x10

5104.0A100.10.0 14203 Ø 100 10x10 cm 120 7.16

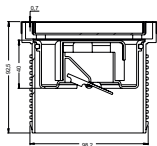
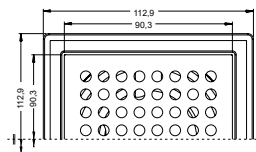

*Plastic body / Stainless interior and exterior frame / Odor blocking by water / Compatible with ceramic Plastic interior frame
 *пластичное тело / Гидро и сухой затвор Рама из нержавеющей стали
 هيكل بلاستيكي / حابس رائحة بصمام مائي / متوافق مع السيراميك إطار الداخلية من البلاستيك

Code Smart Code Dia Size Price \$ ELIT 15x15

5110.0A100.15.0 14205 Ø 100 15x15 cm 80 8.67

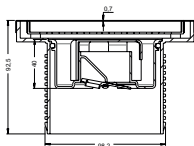
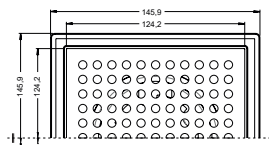

*Plastic body / Stainless interior and exterior frame / Odor blocking by water / Compatible with ceramic Plastic interior frame
 *пластичное тело / Гидро и сухой затвор Рама из нержавеющей стали
 هيكل بلاستيكي / حابس رائحة بصمام مائي / متوافق مع السيراميك إطار الداخلية من البلاستيك

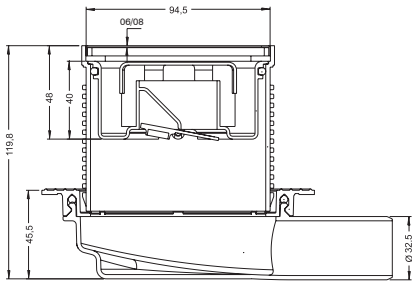

Ø 32 SIDE Outlet

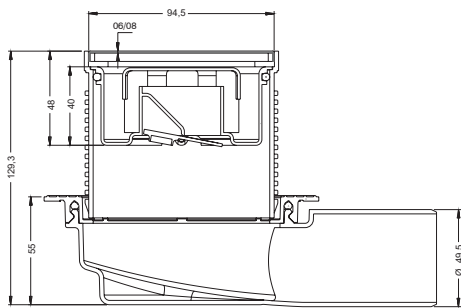
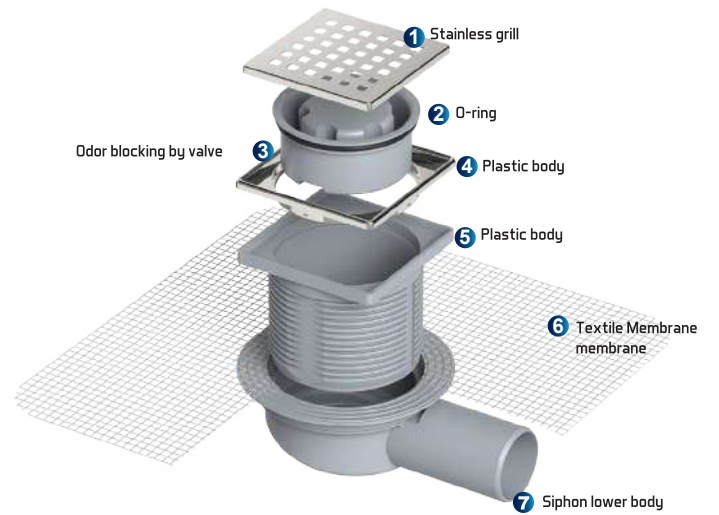
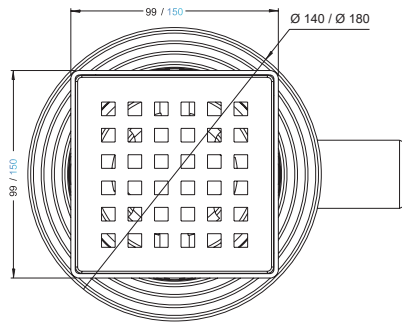

Ø 50 SIDE Outlet

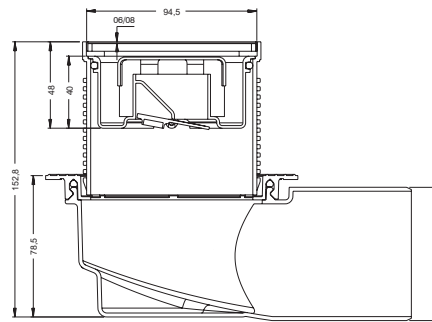

Ø 70 SIDE Outlet

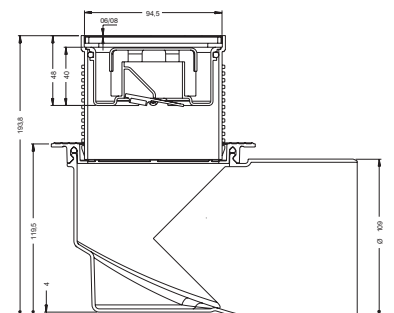

Ø 100 SIDE Outlet

INSULATION IN COMPLIANCE SIPHON

Code Smart Code Outlet Height Price \$ 140 MM

5014.0Y032.00.0	14212	Ø 32	46 mm	125	2.90
5014.0Y040.00.0	14213	Ø 40	55 mm	125	3.00
5014.0Y050.00.0	14215	Ø 50	55 mm	100	3.00
5014.0Y070.00.0	14224	Ø 70	79 mm	75	3.33
5014.0Y100.00.0	14225	Ø 100	115 mm	75	3.67



5014.0A040.00.0	14226	Ø 40	96 mm	140	2.33
5014.0A050.00.0	14227	Ø 50	96 mm	140	2.33
5014.0A070.00.0	14228	Ø 70	96 mm	125	2.33
5014.0A100.00.0	14229	Ø 100	96 mm	75	2.67

Siphon lower body / пластиковое тело
الجسم السفلي

Code Smart Code Outlet Height Price \$ 180 MM

5018.0Y032.00.0	14211	Ø 32	46 mm	100	3.00
5018.0Y040.00.0	14214	Ø 40	55 mm	100	3.34
5018.0Y050.00.0	14216	Ø 50	55 mm	100	3.33
5018.0Y070.00.0	14217	Ø 70	79 mm	75	3.33
5018.0Y100.00.0	14218	Ø 100	115 mm	30	4.33



5018.0A040.00.0	14219	Ø 40	96 mm	100	2.67
5018.0A050.00.0	14220	Ø 50	96 mm	100	2.67
5018.0A070.00.0	14221	Ø 70	96 mm	85	2.67
5018.0A100.00.0	14222	Ø 100	96 mm	75	2.83

Siphon lower body / пластиковое тело
الجسم السفلي

Code Smart Code Outlet Height Price \$ 210 MM

5021.0Y032.00.0	14231	Ø 32	46 mm	100	3.33
5021.0Y040.00.0	14232	Ø 40	55 mm	100	3.67
5021.0Y050.00.0	14233	Ø 50	55 mm	100	3.67
5021.0Y070.00.0	14234	Ø 70	79 mm	70	4.50
5021.0Y100.00.0	14236	Ø 100	115 mm	30	5.17



5021.0A040.00.0	14237	Ø 40	96 mm	100	2.83
5021.0A050.00.0	14239	Ø 50	96 mm	100	2.83
5021.0A070.00.0	14241	Ø 70	96 mm	100	2.83
5021.0A100.00.0	14243	Ø 100	96 mm	70	3.00

Siphon lower body / пластиковое тело
الجسم السفلي

Code Smart Code Outlet Height Price \$ 140 MM MESH

5014.FY032.00.0	14230	Ø 32	46 mm	125	3.67
5014.FY040.00.0	14235	Ø 40	55 mm	125	3.83
5014.FY050.00.0	14238	Ø 50	55 mm	100	3.83
5014.FY070.00.0	14242	Ø 70	79 mm	75	4.18
5014.FY100.00.0	14244	Ø 100	115 mm	75	5.00



5014.FA040.00.0	14246	Ø 40	96 mm	100	3.17
5014.FA050.00.0	14247	Ø 50	96 mm	100	3.17
5014.FA070.00.0	14248	Ø 70	96 mm	75	3.33
5014.FA100.00.0	14249	Ø 100	96 mm	75	3.33



Siphon lower body / пластиковое тело
الجسم السفلي

Code Smart Code Outlet Height Price \$ 180 MM MESH

5018.FY032.00.0	14245	Ø 32	46 mm	100	3.67
5018.FY040.00.0	14250	Ø 40	55 mm	100	3.83
5018.FY050.00.0	14251	Ø 50	55 mm	100	3.83
5018.FY070.00.0	14253	Ø 70	79 mm	75	4.17
5018.FY100.00.0	14255	Ø 100	115 mm	72	4.67



5018.FA040.00.0	14262	Ø 40	96 mm	100	3.67
5018.FA050.00.0	14265	Ø 50	96 mm	90	3.67
5018.FA070.00.0	14266	Ø 70	96 mm	85	3.67
5018.FA100.00.0	14267	Ø 100	96 mm	72	3.83

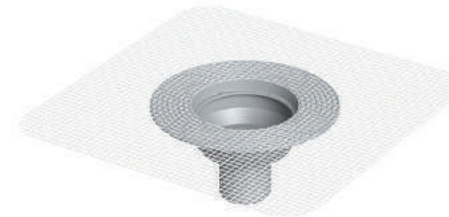
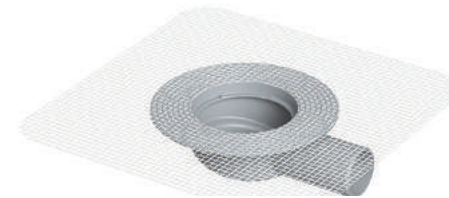

Siphon lower body / пластиковое тело
الجسم السفلي

Code Smart Code Outlet Height Price \$ 140 MM T.MEMBRANE

5014.TY032.00.0	14252	Ø 32	46 mm	125	4.33
5014.TY040.00.0	14254	Ø 40	55 mm	125	4.50
5014.TY050.00.0	14256	Ø 50	55 mm	100	4.50
5014.TY070.00.0	14257	Ø 70	79 mm	75	5.00
5014.TY100.00.0	14258	Ø 100	115 mm	75	5.50



5014.TA040.00.0	14259	Ø 40	96 mm	100	4.00
5014.TA050.00.0	14260	Ø 50	96 mm	100	4.00
5014.TA070.00.0	14261	Ø 70	96 mm	75	4.17
5014.TA100.00.0	14263	Ø 100	96 mm	75	4.17

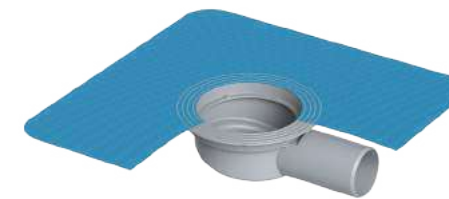

Siphon lower body / пластиковое тело
الجسم السفلي

Code Smart Code Outlet Height Price \$ 180 MM T.MEMBRANE

5018.TY032.00.0	14264	Ø 32	46 mm	100	4.33
5018.TY040.00.0	14268	Ø 40	55 mm	100	4.33
5018.TY050.00.0	14270	Ø 50	55 mm	90	4.33
5018.TY070.00.0	14271	Ø 70	79 mm	75	4.83
5018.TY100.00.0	14272	Ø 100	115 mm	50	5.33

5018.TA040.00.0	14273	Ø 40	96 mm	85	4.33
5018.TA050.00.0	14276	Ø 50	96 mm	85	4.33
5018.TA070.00.0	14278	Ø 70	96 mm	75	4.33
5018.TA100.00.0	14280	Ø 100	96 mm	75	4.33

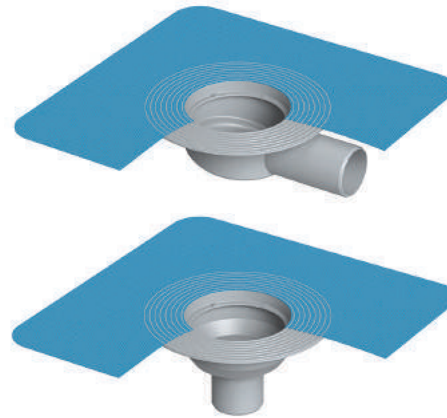

Siphon lower body / пластичное тело
الجسم السفلي

Code Smart Code Outlet Height Price \$ 210 MM MEMBRANE

5021.MY032.00.0	14269	Ø 32	50 mm	35	8.33
5021.MY040.00.0	14274	Ø 40	59 mm	35	8.33
5021.MY050.00.0	14277	Ø 50	59 mm	35	8.33
5021.MY070.00.0	14279	Ø 70	84 mm	30	8.68
5021.MY100.00.0	14281	Ø 100	119 mm	30	9.00

5021.MA040.00.0	14283	Ø 40	100 mm	30	8.00
5021.MA050.00.0	14284	Ø 50	100 mm	30	8.00
5021.MA070.00.0	14285	Ø 70	100 mm	30	8.00
5021.MA100.00.0	14287	Ø 100	100 mm	30	8.00

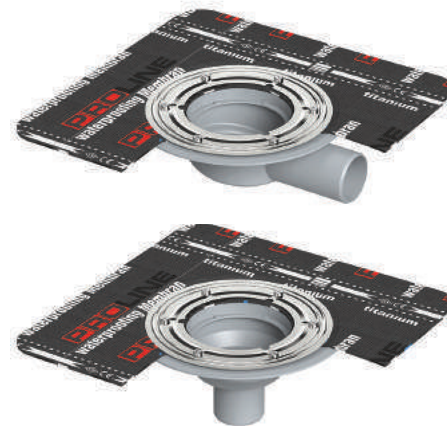

Plastic body / Stainless Steel Flanges set
пластичное тело / Изоляция совместимый / Мембраны
الجسم السفلي فريق القوالب المقاوم للصدأ الشفاه

Vertical Outlet Size LER1

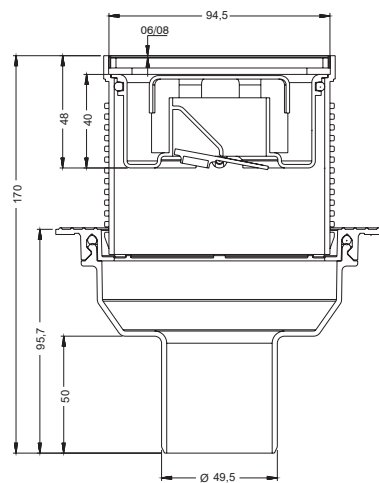

Ø 50 Vertical Outlet

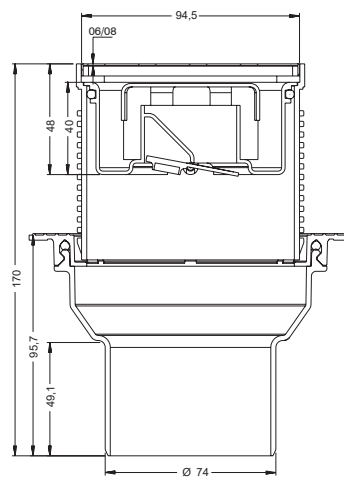

Ø 70 Vertical Outlet

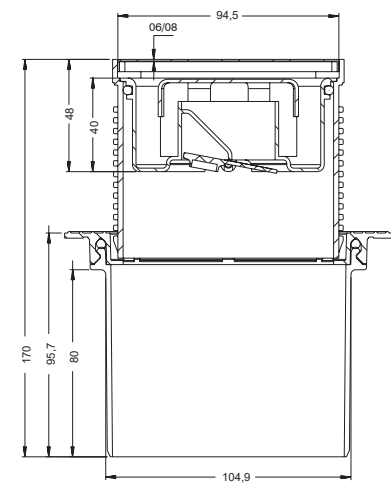

Ø 100 Vertical Outlet

Code

Smart Code

Outlet

Size



Price \$

140 MM 10x10 DUVAR DIBI

5054.0Y032.10.1	14282	Ø 32	10x10 cm	50	7.83
5054.0Y040.10.1	14286	Ø 40	10x10 cm	50	7.83
5054.0Y050.10.1	14289	Ø 50	10x10 cm	50	7.83
5054.0Y070.10.1	14290	Ø 70	10x10 cm	50	8.17
5054.0Y100.10.1	14291	Ø 100	10x10 cm	50	8.67



5054.0A040.10.1	14292	Ø 40	10x10 cm	50	7.67
5054.0A050.10.1	14293	Ø 50	10x10 cm	50	7.67
5054.0A070.10.1	14294	Ø 70	10x10 cm	50	7.67
5054.0A100.10.1	14295	Ø 100	10x10 cm	50	7.67



*Plastic body / Stainless steel grid / Odor blocking by water
*пластичное тело / Нержавеющая решетка / Сухой Затвор
هيكل بلاستيكي / شبكة مقاومة للصدأ / حابس رائحة مائي بصمام

Code

Smart Code

Outlet

Size



Price \$

180 MM 10x10

5058.0Y032.10.1	14288	Ø 32	10x10 cm	50	8.00
5058.0Y040.10.1	14296	Ø 40	10x10 cm	50	8.00
5058.0Y050.10.1	14299	Ø 50	10x10 cm	50	8.00
5058.0Y070.10.1	14302	Ø 70	10x10 cm	50	8.50
5058.0Y100.10.1	14303	Ø 100	10x10 cm	50	9.00



5058.0A040.10.1	14305	Ø 40	10x10 cm	50	7.83
5058.0A050.10.1	14307	Ø 50	10x10 cm	50	7.83
5058.0A070.10.1	14309	Ø 70	10x10 cm	50	7.83
5058.0A100.10.1	14311	Ø 100	10x10 cm	50	7.83



*Plastic body / Stainless steel grid / Odor blocking by water
*пластичное тело / Нержавеющая решетка / Сухой Затвор
هيكل بلاستيكي / شبكة مقاومة للصدأ / حابس رائحة مائي بصمام

Code

Smart Code

Outlet

Size



Price \$

180 MM 15x15

5058.0Y032.15.1	14298	Ø 32	15x15cm	50	10.33
5058.0Y040.15.1	14300	Ø 40	15x15cm	50	10.50
5058.0Y050.15.1	14301	Ø 50	15x15cm	50	10.50
5058.0Y070.15.1	14304	Ø 70	15x15cm	50	11.17
5058.0Y100.15.1	14306	Ø 100	15x15cm	50	12.00



5058.0A040.15.1	14308	Ø 40	15x15cm	50	10.00
5058.0A050.15.1	14310	Ø 50	15x15cm	50	10.00
5058.0A070.15.1	14312	Ø 70	15x15cm	50	10.00
5058.0A100.15.1	14314	Ø 100	15x15cm	50	10.00



*Plastic body / Stainless steel grid / Odor blocking by water
*пластичное тело / Нержавеющая решетка / Сухой Затвор
هيكل بلاستيكي / شبكة مقاومة للصدأ / حابس رائحة مائي بصمام

Code Smart Code Outlet Size Price \$ 140 MM 10x10 MESH

5054.FY032.10.1	14313	Ø 32	10x10 cm	50	8.17
5054.FY040.10.1	14319	Ø 40	10x10 cm	50	8.17
5054.FY050.10.1	14321	Ø 50	10x10 cm	50	8.17
5054.FY070.10.1	14322	Ø 70	10x10 cm	50	8.67
5054.FY100.10.1	14323	Ø 100	10x10 cm	50	9.67

5054.FA040.10.1	14324	Ø 40	10x10 cm	50	8.00
5054.FA050.10.1	14325	Ø 50	10x10 cm	50	8.00
5054.FA070.10.1	14326	Ø 70	10x10 cm	50	8.00
5054.FA100.10.1	14327	Ø 100	10x10 cm	50	8.00

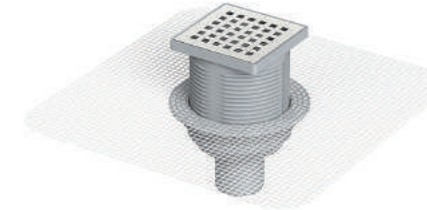
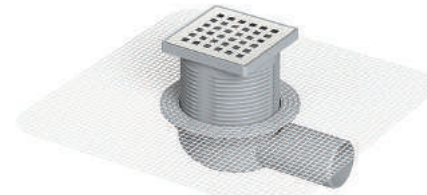

*Plastic body / Stainless steel grid / Odor blocking by water
 *пластичное тело / Нержавеющая решетка / Сухой Затвор
 هيكل بلاستيكي / شبكة مقاومة للصدأ / حابس رائحة مائي بصمام

Code Smart Code Outlet Size Price \$ 180 MM 10x10 MESH

5058.FY032.10.1	14315	Ø 32	10x10 cm	50	8.33
5058.FY040.10.1	14316	Ø 40	10x10 cm	50	8.33
5058.FY050.10.1	14317	Ø 50	10x10 cm	50	8.33
5058.FY070.10.1	14318	Ø 70	10x10 cm	50	9.00
5058.FY100.10.1	14320	Ø 100	10x10 cm	50	9.33

5058.FA040.10.1	14328	Ø 40	10x10 cm	50	8.18
5058.FA050.10.1	14330	Ø 50	10x10 cm	50	8.18
5058.FA070.10.1	14331	Ø 70	10x10 cm	50	8.18
5058.FA100.10.1	14332	Ø 100	10x10 cm	50	8.18

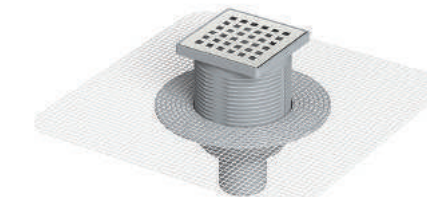
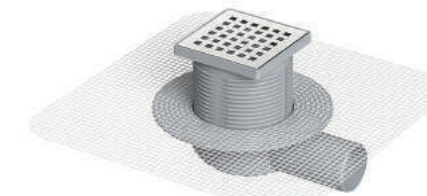

*Plastic body / Stainless steel grid / Odor blocking by water
 *пластичное тело / Нержавеющая решетка / Сухой Затвор
 هيكل بلاستيكي / شبكة مقاومة للصدأ / حابس رائحة مائي بصمام

Code Smart Code Outlet Size Price \$ 180 MM 15x15 MESH

5058.FY032.15.1	14333	Ø 32	15x15cm	50	11.67
5058.FY040.15.1	14334	Ø 40	15x15cm	50	11.83
5058.FY050.15.1	14335	Ø 50	15x15cm	50	11.83
5058.FY070.15.1	14336	Ø 70	15x15cm	50	12.00
5058.FY100.15.1	14337	Ø 100	15x15cm	50	13.00

5058.FA040.15.1	14338	Ø 40	15x15cm	50	11.50
5058.FA050.15.1	14340	Ø 50	15x15cm	50	11.50
5058.FA070.15.1	14341	Ø 70	15x15cm	50	11.50
5058.FA100.15.1	14344	Ø 100	15x15cm	50	11.50

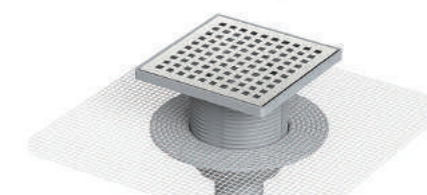
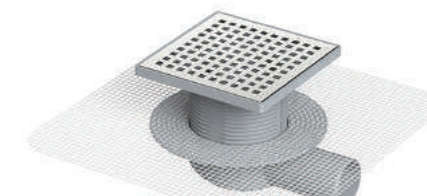

*Plastic body / Stainless steel grid / Odor blocking by water
 *пластичное тело / Нержавеющая решетка / Сухой Затвор
 هيكل بلاستيكي / شبكة مقاومة للصدأ / حابس رائحة مائي بصمام

Code Smart Code Outlet Size Price \$ 140 MM 10x10 T.MEMBRANE

5054.TY032.10.1	14342	Ø 32	10x10 cm	50	9.32
5054.TY040.10.1	14346	Ø 40	10x10 cm	50	9.67
5054.TY050.10.1	14349	Ø 50	10x10 cm	50	9.67
5054.TY070.10.1	14351	Ø 70	10x10 cm	50	9.83
5054.TY100.10.1	14353	Ø 100	10x10 cm	50	10.50



5054.TA040.10.1	14356	Ø 40	10x10 cm	50	9.17
5054.TA050.10.1	14357	Ø 50	10x10 cm	50	9.67
5054.TA070.10.1	14359	Ø 70	10x10 cm	50	9.67
5054.TA100.10.1	14361	Ø 100	10x10 cm	50	10.00

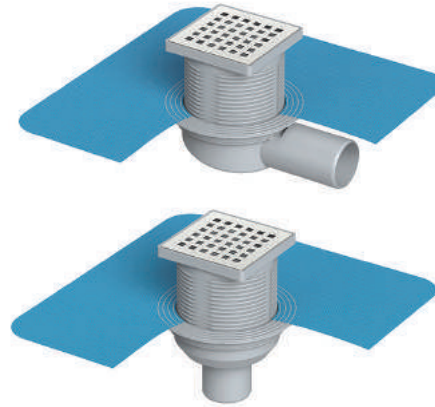

*Plastic body / Stainless steel grid / Odor blocking by water
 *пластичное тело / Нержавеющая решетка / Сухой Затвор
 هيكل بلاستيكي / شبكة مقاومة للصدأ / حابس رائحة مائي بصمام

Code Smart Code Outlet Size Price \$ 180 MM 10x10 T.MEMBRANE

5058.TY032.10.1	14345	Ø 32	10x10 cm	50	9.67
5058.TY040.10.1	14348	Ø 40	10x10 cm	50	9.83
5058.TY050.10.1	14350	Ø 50	10x10 cm	50	9.83
5058.TY070.10.1	14352	Ø 70	10x10 cm	50	10.00
5058.TY100.10.1	14354	Ø 100	10x10 cm	50	10.50



5058.TA040.10.1	14355	Ø 40	10x10 cm	50	9.08
5058.TA050.10.1	14358	Ø 50	10x10 cm	50	9.32
5058.TA070.10.1	14360	Ø 70	10x10 cm	50	9.32
5058.TA100.10.1	14362	Ø 100	10x10 cm	50	9.67

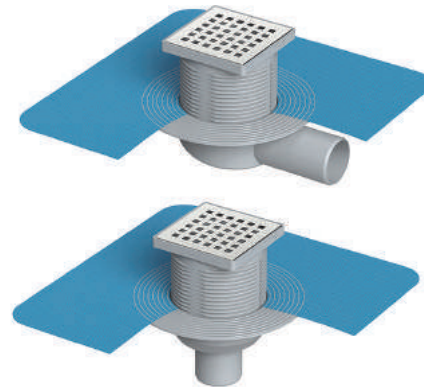

*Plastic body / Stainless steel grid / Odor blocking by water
 *пластичное тело / Нержавеющая решетка / Сухой Затвор
 هيكل بلاستيكي / شبكة مقاومة للصدأ / حابس رائحة مائي بصمام

Code Smart Code Outlet Size Price \$ 180 MM 15x15 T.MEMBRANE

5058.TY032.15.1	14364	Ø 32	15x15cm	50	12.50
5058.TY040.15.1	14365	Ø 40	15x15cm	50	12.67
5058.TY050.15.1	14366	Ø 50	15x15cm	50	12.67
5058.TY070.15.1	14367	Ø 70	15x15cm	50	13.16
5058.TY100.15.1	14368	Ø 100	15x15cm	50	13.67



5058.TA040.15.1	14369	Ø 40	15x15cm	50	12.50
5058.TA050.15.1	14370	Ø 50	15x15cm	50	12.83
5058.TA070.15.1	14371	Ø 70	15x15cm	50	12.83
5058.TA100.15.1	14372	Ø 100	15x15cm	50	13.00

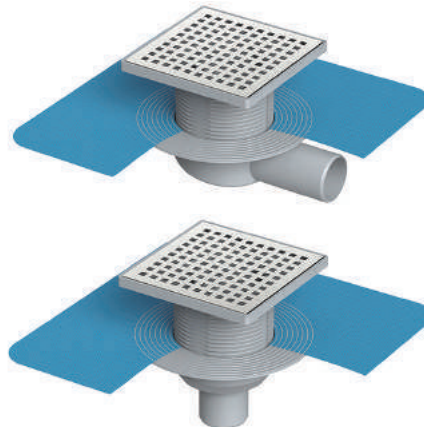

*Plastic body / Stainless steel grid / Odor blocking by water
 *пластичное тело / Нержавеющая решетка / Сухой Затвор
 هيكل بلاستيكي / شبكة مقاومة للصدأ / حابس رائحة مائي بصمام

Code Smart Code Outlet Size Price \$ 210 MM 10x10 MEMBRANE

5061.MY032.10.1	14363	Ø 32	10x10 cm	50	12.85
5061.MY040.10.1	14373	Ø 40	10x10 cm	50	13.17
5061.MY050.10.1	14374	Ø 50	10x10 cm	50	13.17
5061.MY070.10.1	14375	Ø 70	10x10 cm	50	13.67
5061.MY100.10.1	14377	Ø 100	10x10 cm	50	14.50



*Plastic body / Stainless steel grid / Odor blocking by water
 *пластичное тело / Нержавеющая решетка / Сухой Затвор
 هيكل بلاستيكي / شبكة مقاومة للصدأ / حابس رائحة مائي بصمام

Code Smart Code Outlet Size Price \$ 210 MM 15x15 MEMBRANE

5061.MY032.15.1	14376	Ø 32	15x15cm	50	15.00
5061.MY040.15.1	14381	Ø 40	15x15cm	50	15.17
5061.MY050.15.1	14382	Ø 50	15x15cm	50	15.17
5061.MY070.15.1	14383	Ø 70	15x15cm	50	15.67
5061.MY100.15.1	14384	Ø 100	15x15cm	50	16.17



*Plastic body / Stainless steel grid / Odor blocking by water
 *пластичное тело / Нержавеющая решетка / Сухой Затвор
 هيكل بلاستيكي / شبكة مقاومة للصدأ / حابس رائحة مائي بصمام

